

| NO | MODEL | Length | Width | Thk | No Holes | NO | MODEL | Length | Width | Thk | No Holes |
|----|--------------------|--------|-------|-----|----------|----|--------------|--------|-------|-----|----------|
| 01 | TOK | 283 | 43 | 3.0 | 4 | 29 | KOR | 600 | 50 | 2.0 | 10 |
| 02 | TOK | 283 | 43 | 0.5 | 4 | 30 | KORA | 622 | 50 | 2.0 | 10 |
| 03 | Quickmaster | 375 | 43 | 3.0 | 5 | 31 | KORD 62 | 650 | 50 | 2.0 | 10 |
| 04 | GTO46 | 500 | 60 | 0.5 | 5 | 32 | KORD 64 | 690 | 50 | 2.0 | 12 |
| 05 | GTO46 | 448 | 40 | 6.0 | 3 | 33 | KORS | 760 | 50 | 2.0 | 12 |
| 06 | GTO52 | 560 | 60 | 0.5 | 6 | 34 | SOR | 890 | 50 | 2.0 | 10 |
| 07 | GTO52 | 508 | 40 | 6.0 | 3 | 35 | SOR Z | 890 | 51 | 2.0 | 9 |
| 08 | MO | 710 | 60 | 0.5 | 8 | 36 | SORD | 960 | 60 | 0.5 | 10 |
| 09 | MO | 692 | 60 | 0.5 | 7 | 37 | SORD | 960 | 50 | 2.0 | 12 |
| 10 | MO | 710 | 60 | 2.0 | 8 | 38 | SORK | 710 | 60 | 0.5 | 8 |
| 11 | MO | 720 | 60 | 0.5 | 8 | 39 | SORK | 721 | 50 | 2.0 | 12 |
| 12 | MO | 648 | 52 | 6.0 | 3 | 40 | SORM | 790 | 60 | 0.5 | 11 |
| 13 | Speedmaster 52 | 605 | 46 | 0.5 | 7 | 41 | SORM | 790 | 50 | 2.0 | 12 |
| 14 | Speedmaster 72 | 790 | 60 | 0.5 | 11 | 42 | SORM Z | 753 | 42 | 0.5 | 9 |
| 15 | Speedmaster 72 VP | 753 | 40 | 0.5 | 9 | 43 | SORM Z | 790 | 60 | 0.5 | 11 |
| 16 | Speedmaster 72 | 790 | 60 | 0.5 | 11 | 44 | SORS | 1090 | 60 | 0.5 | 11 |
| 17 | Speedmaster 72 | 742 | 57 | 0.5 | 8 | 45 | 8 Page Web | 570 | 51 | 2.0 | 8 |
| 18 | Speedmaster 74 | 820 | 57 | 0.5 | 9 | 46 | 16 Page Web | 1036 | 51 | 2.0 | 12 |
| 19 | Speedmaster 102 | 1090 | 60 | 0.5 | 11 | 47 | PLATEN 10x15 | 390 | 51 | 6.0 | 5 |
| 20 | Speedmaster 102 | 1090 | 60 | 3.0 | 11 | 48 | PLATEN 13x18 | 470 | 51 | 6.0 | 6 |
| 21 | Speedmaster 102 | 1090 | 60 | 5.0 | 11 | 49 | KS | 530 | 45.6 | 1.0 | 8 |
| 22 | Speedmaster 102 | 1090 | 60 | 0.5 | 11 | 50 | KSB & KSBA | 572 | 45.6 | 1.0 | 8 |
| 23 | Speedmaster 102 | 1042 | 60 | 0.5 | 11 | 51 | KSD | 648 | 48 | 1.0 | 8 |
| 24 | Speedmaster 102 | 1042 | 57 | 0.5 | 11 | 52 | OHZ | 720 | 45.6 | 1.0 | 10 |
| 25 | Speedmaster 102 | 1042 | 57 | 5.0 | 11 | 53 | SB & SBG | 770 | 45.6 | 1.0 | 10 |
| 26 | Speedmaster 102 CD | 1090 | 60 | 0.5 | 11 | 54 | SBB | 810 | 45.6 | 1.0 | 10 |
| 27 | Speedmaster 102 VP | 1052 | 40 | 0.5 | 11 | 55 | SBG Group 11 | 835 | 50 | 1.0 | 8 |
| 28 | Rotaspeed | 1050 | 60 | 0.5 | 11 | 56 | SBD | 884 | 45.6 | 1.0 | 10 |

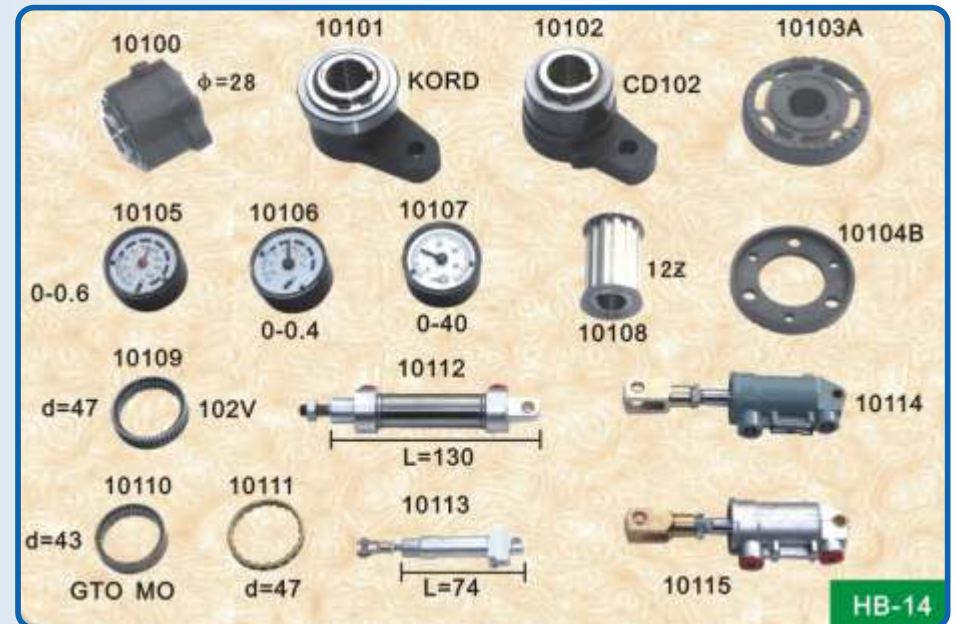

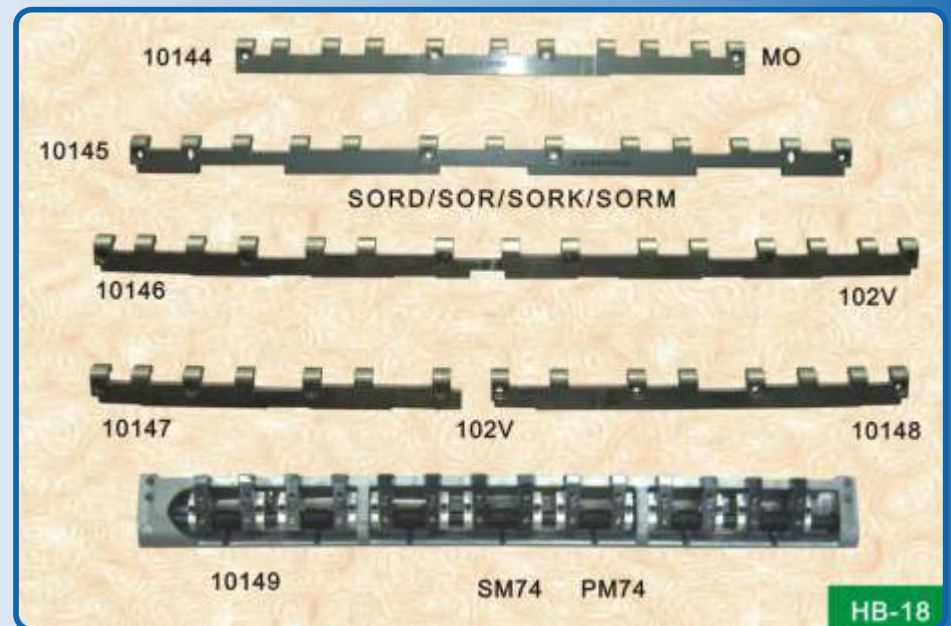

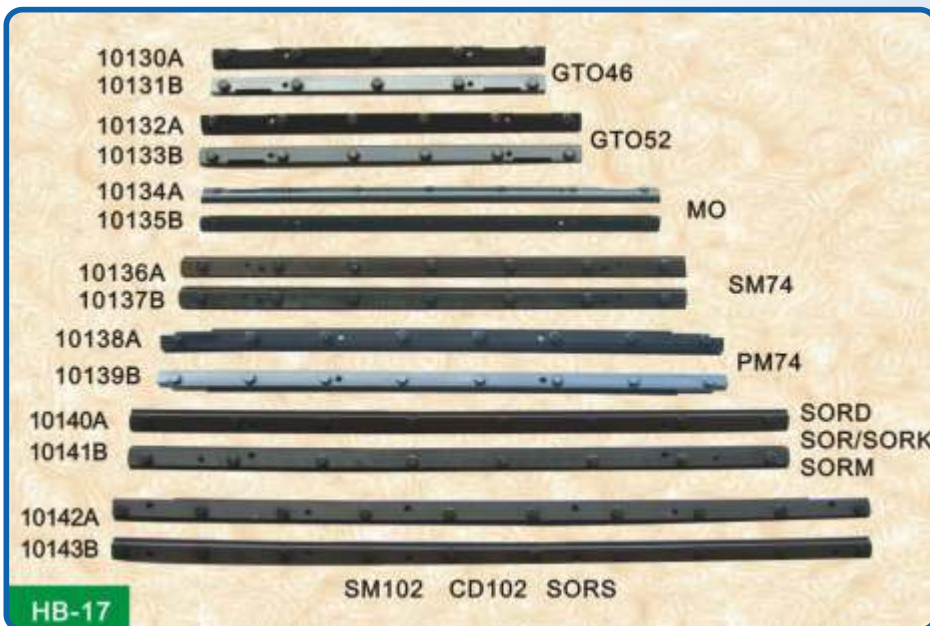

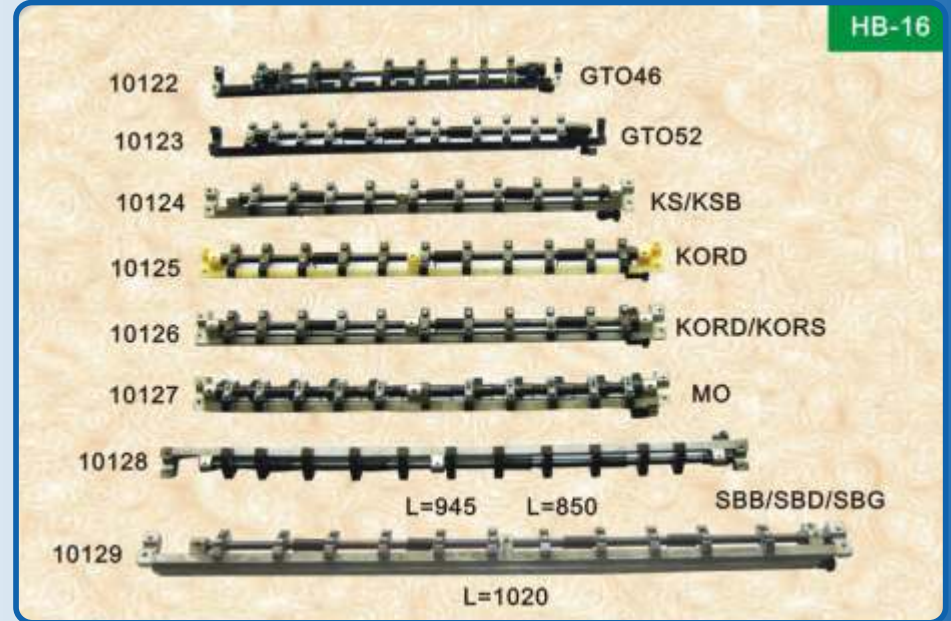
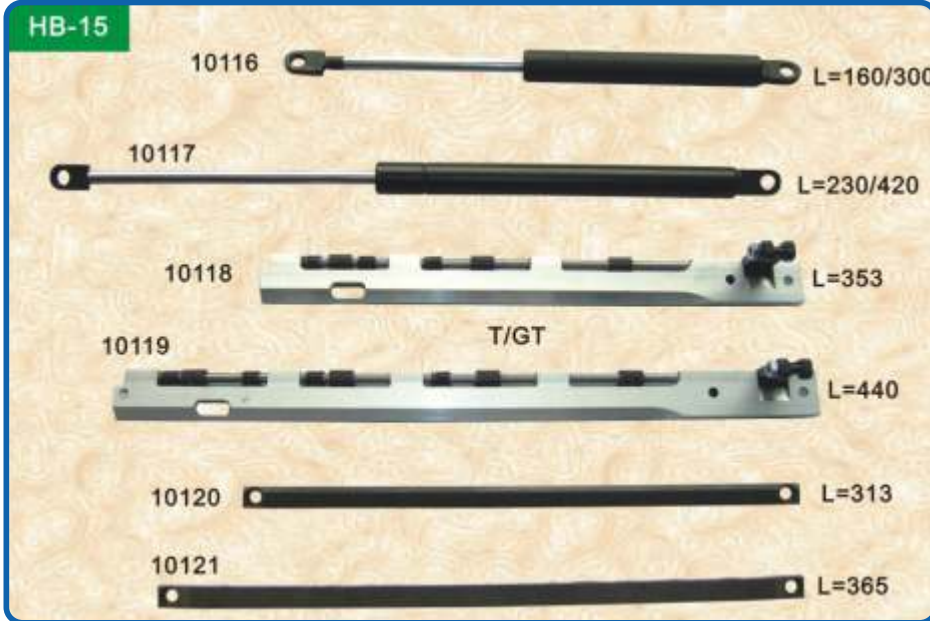
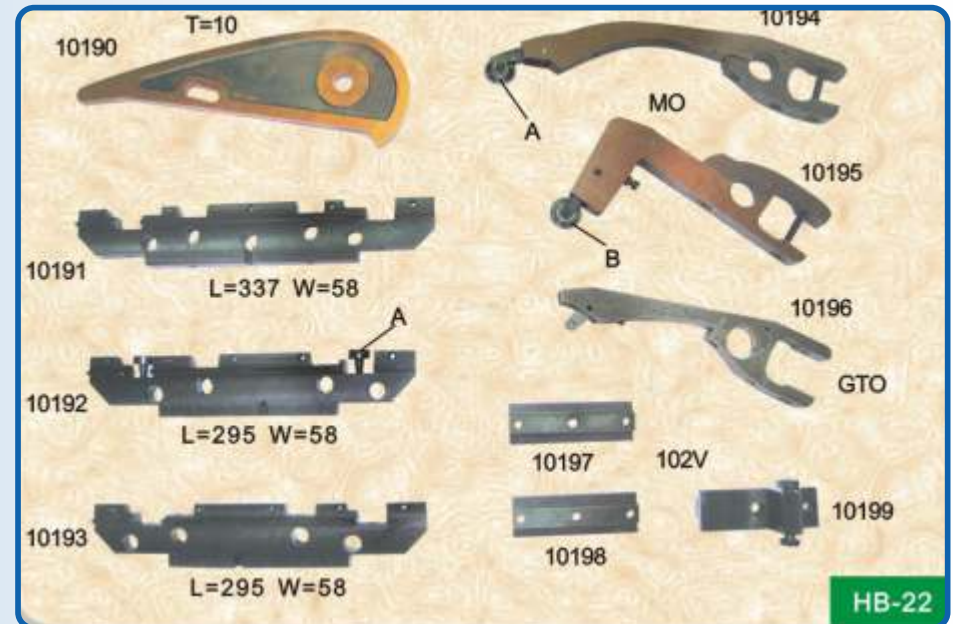
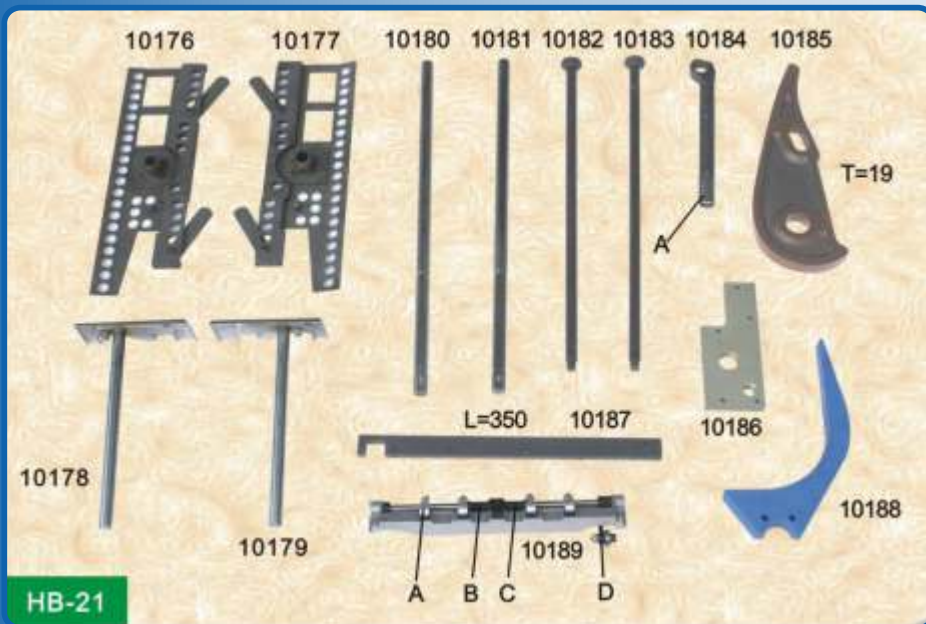
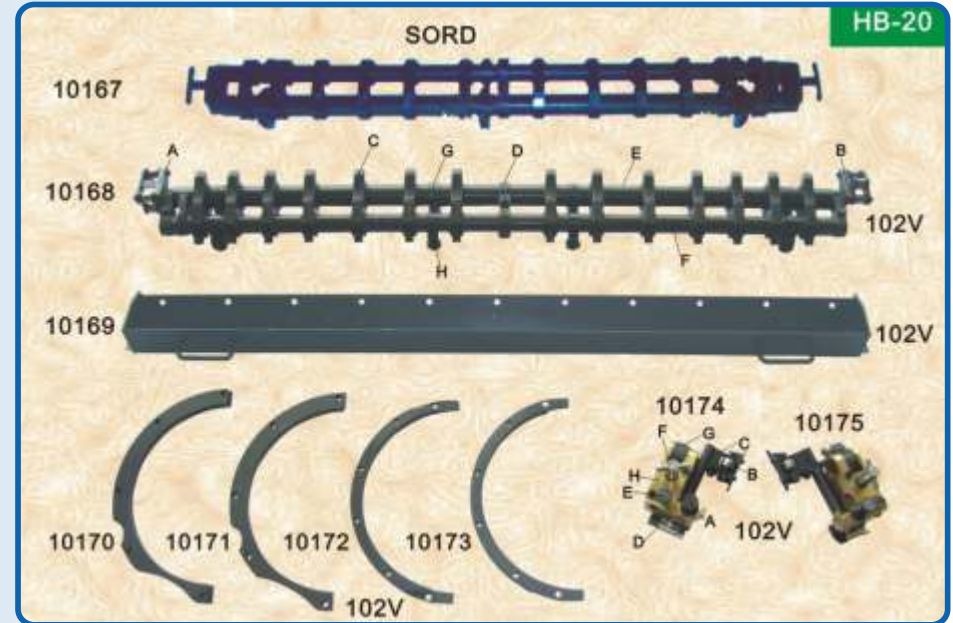
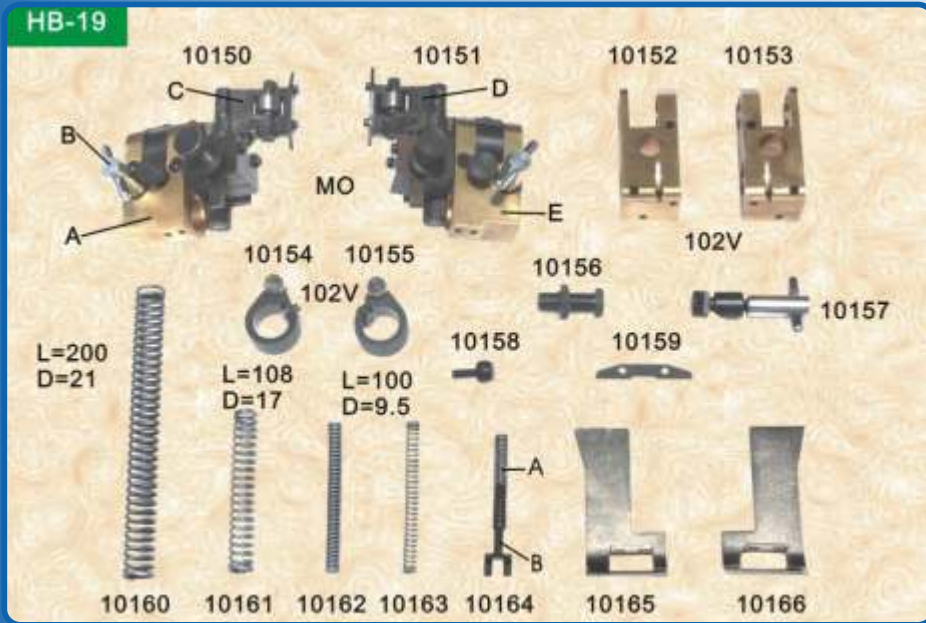
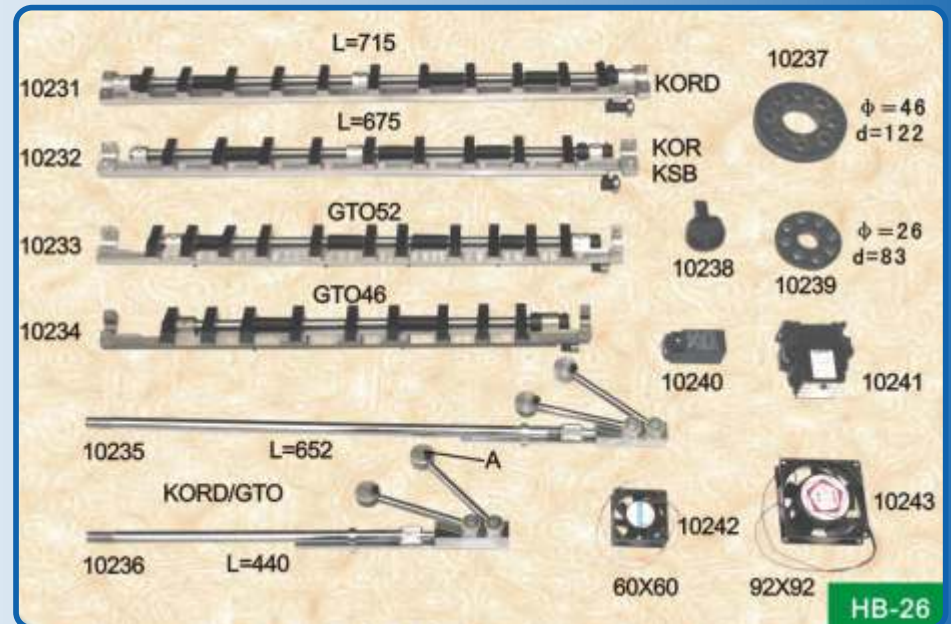
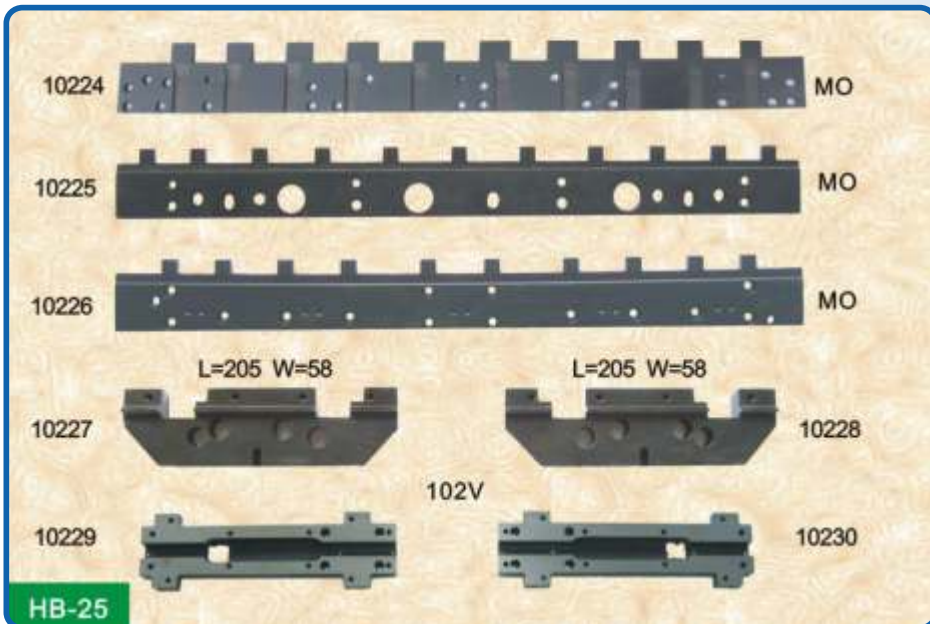
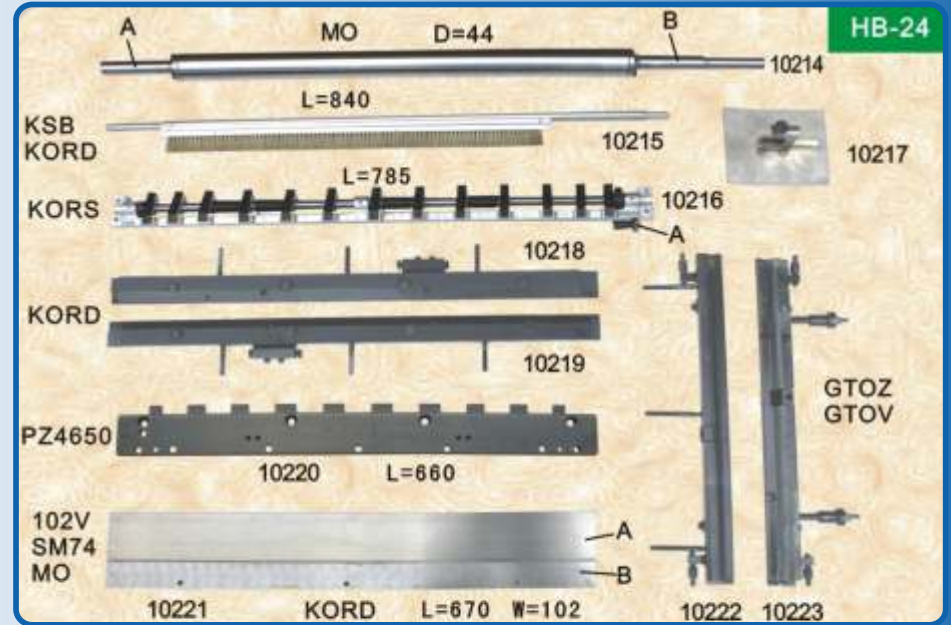
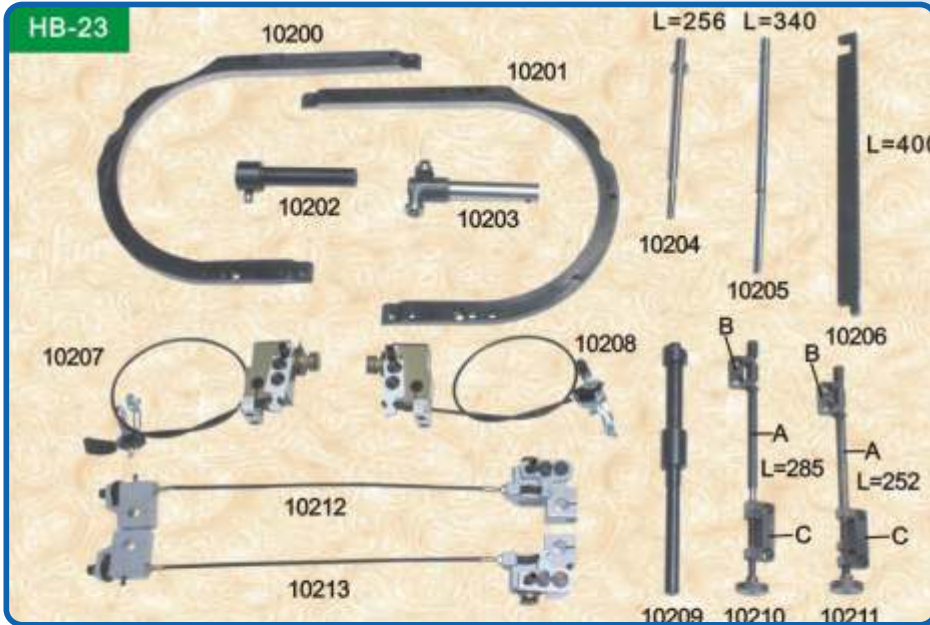

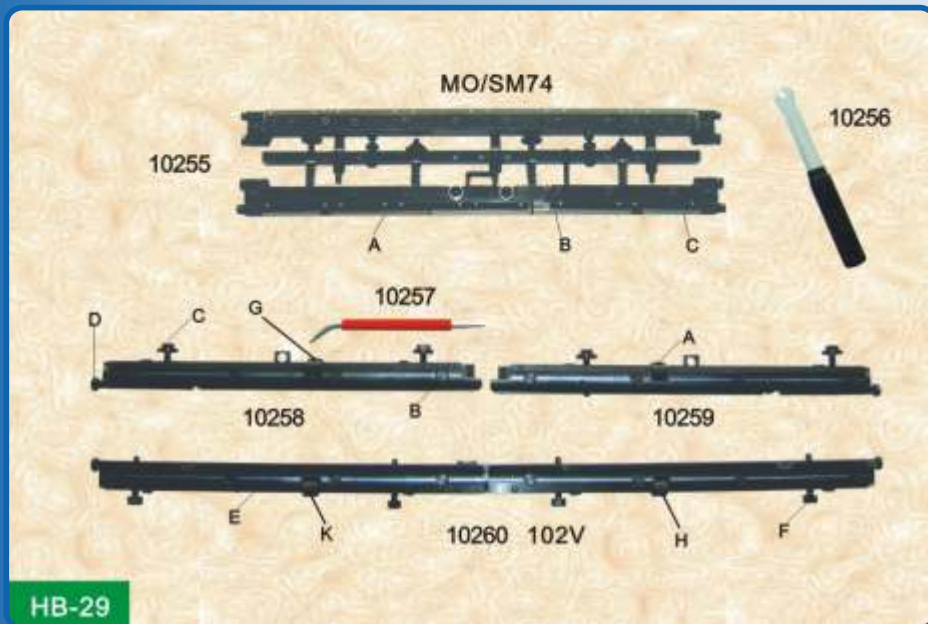
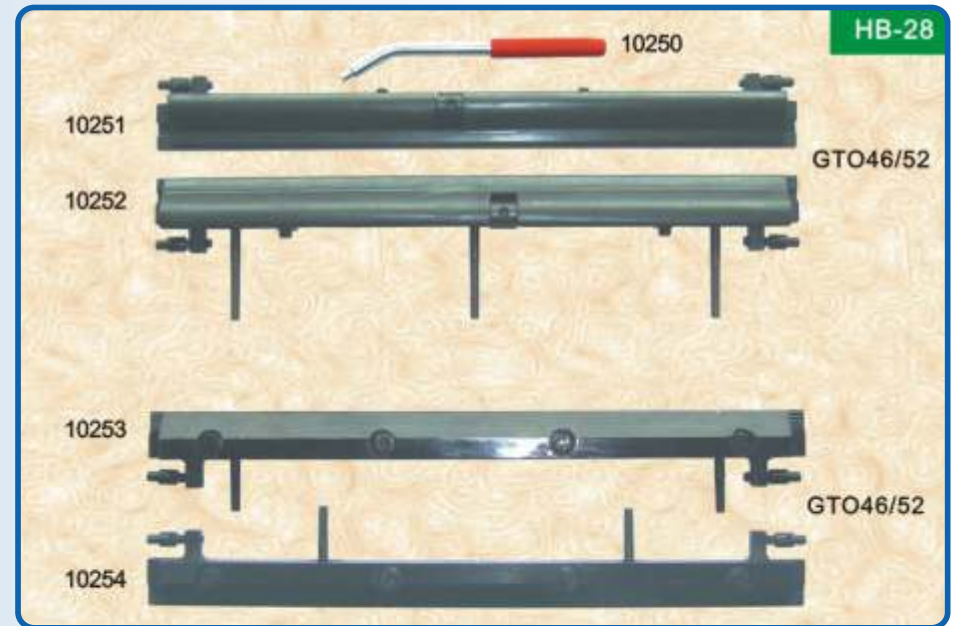
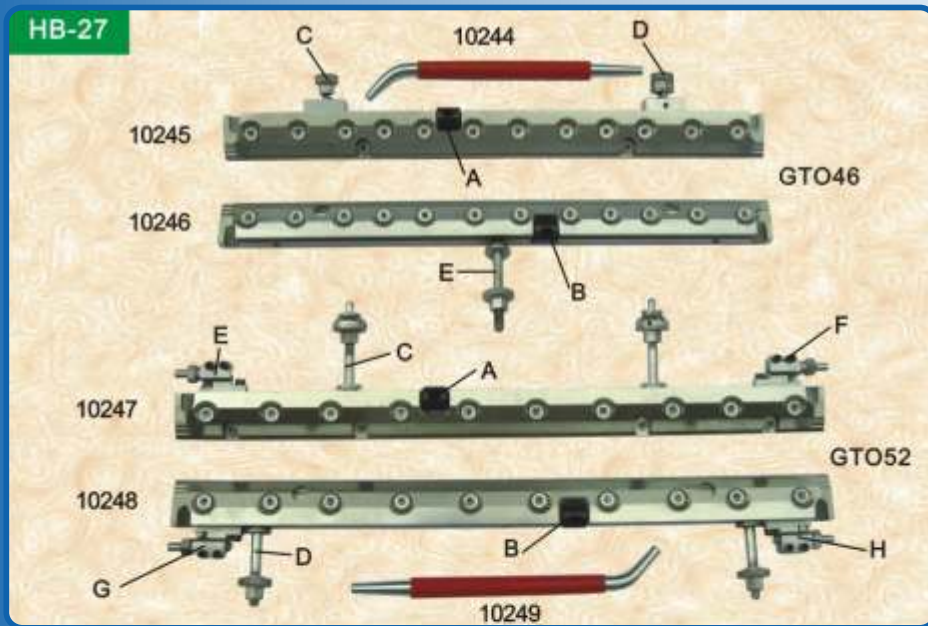

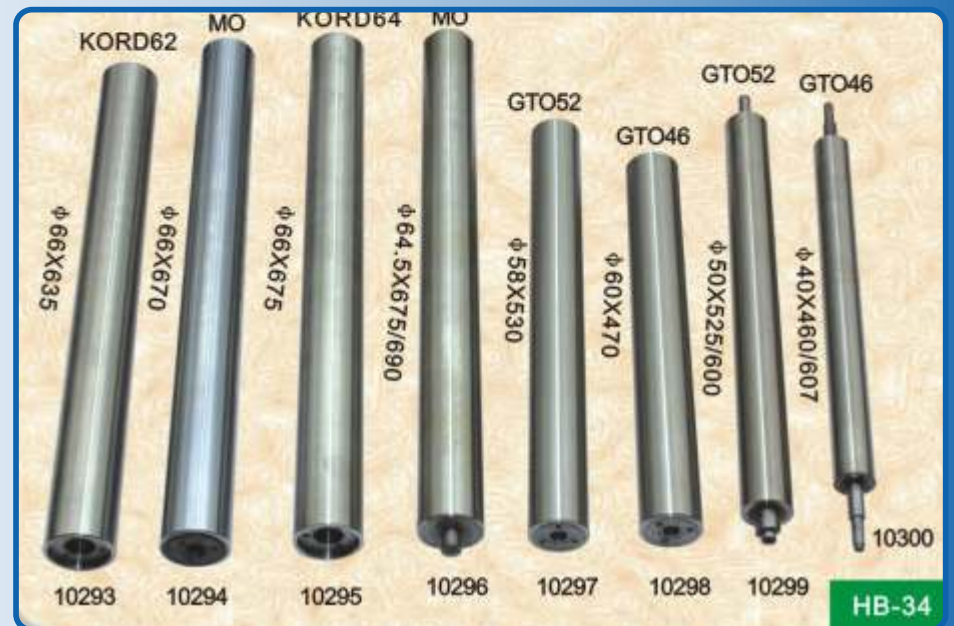
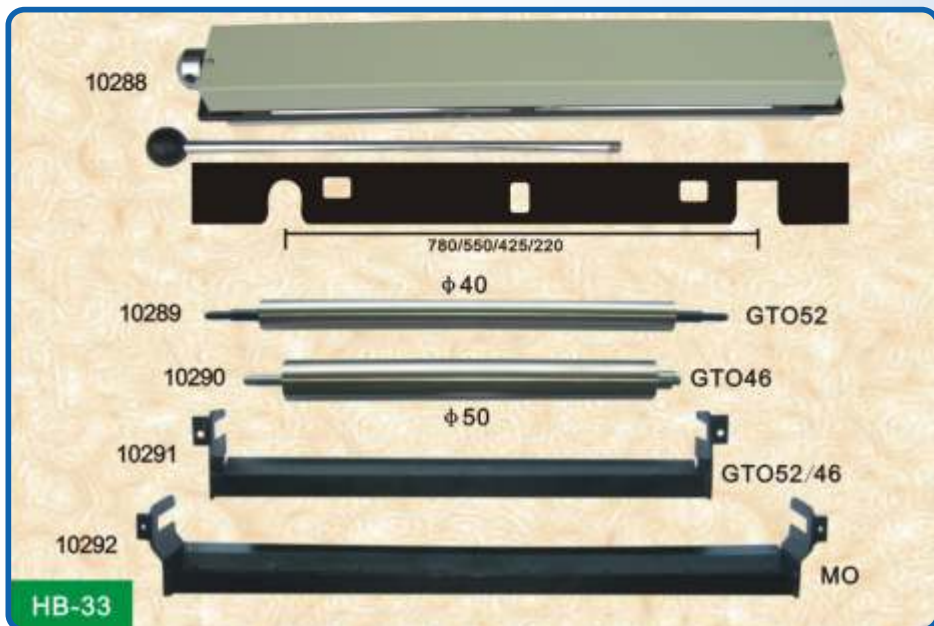
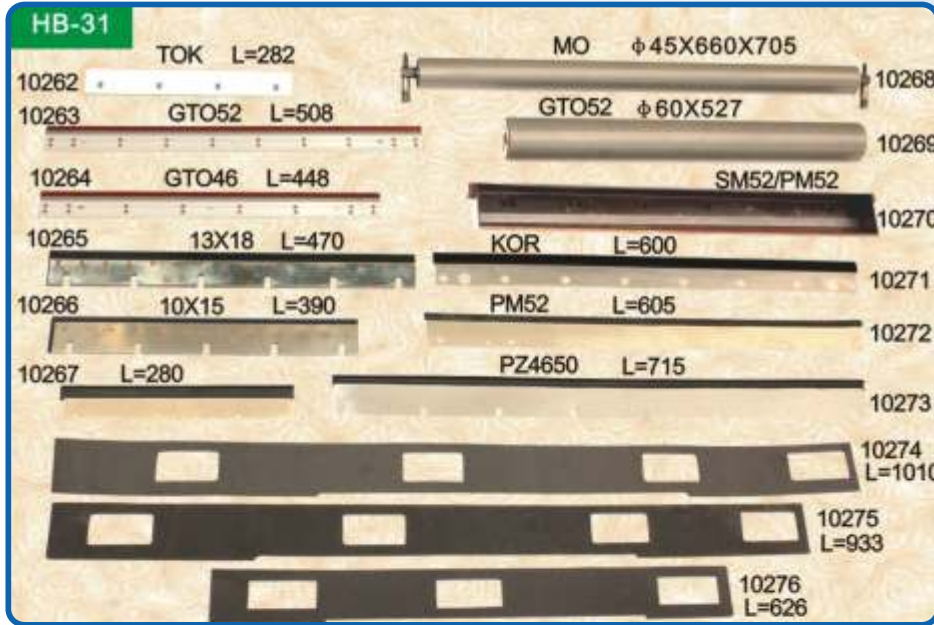

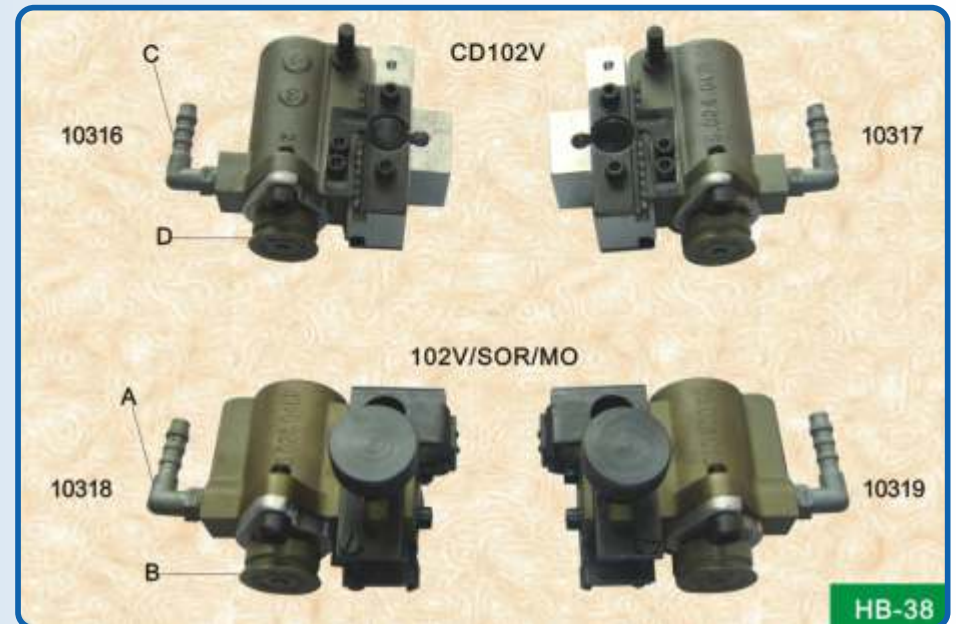
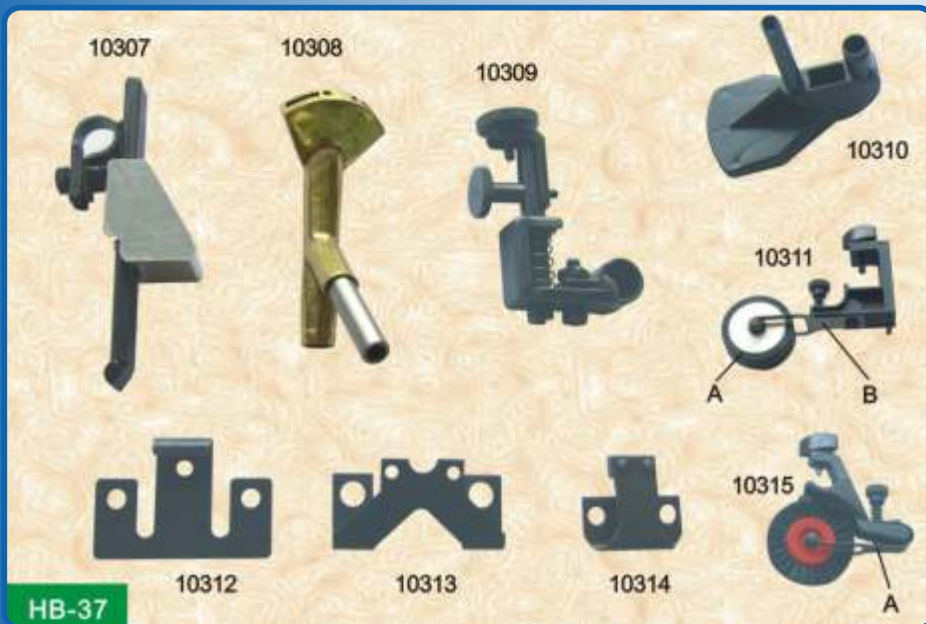
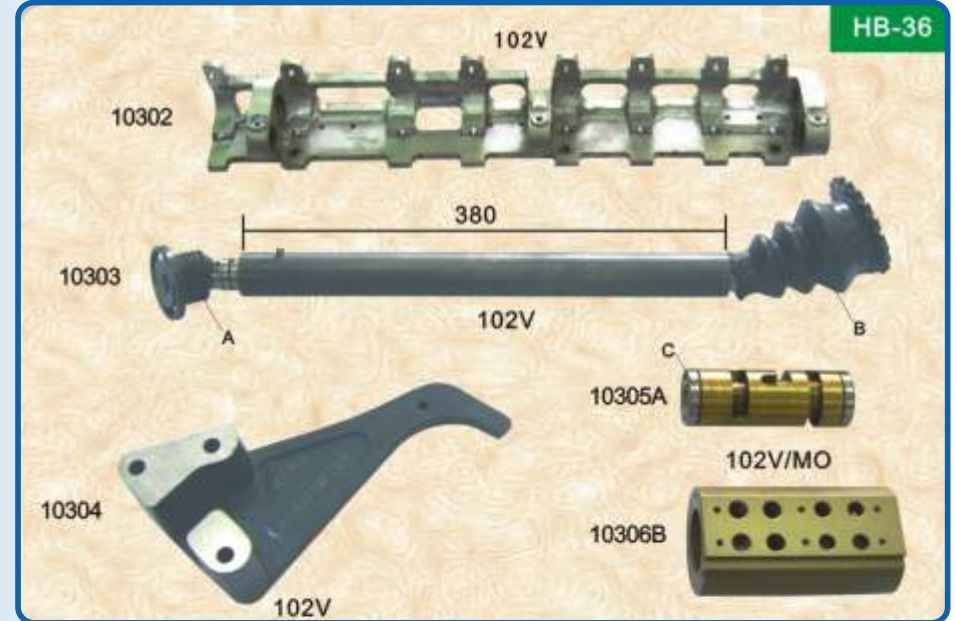
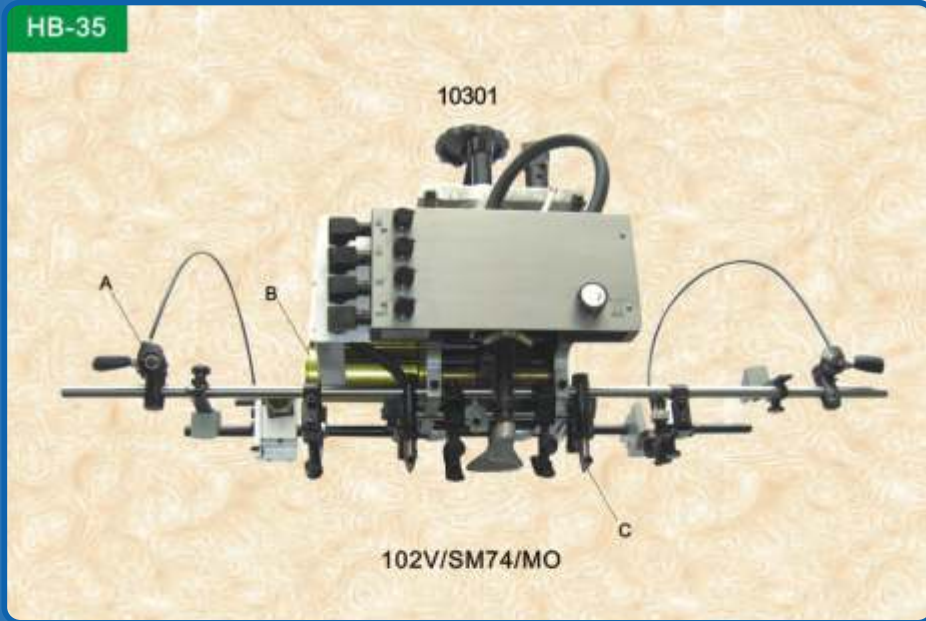

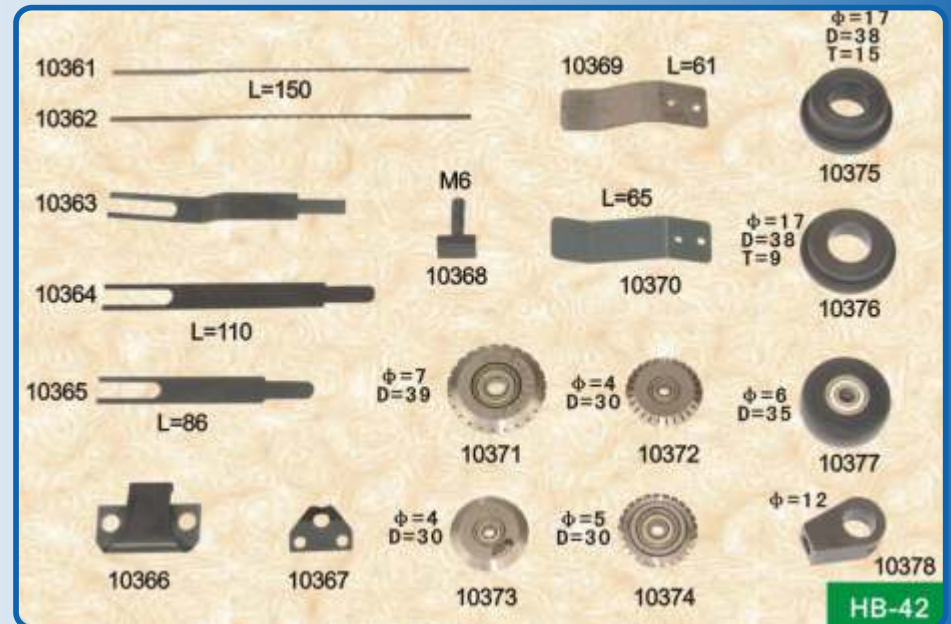
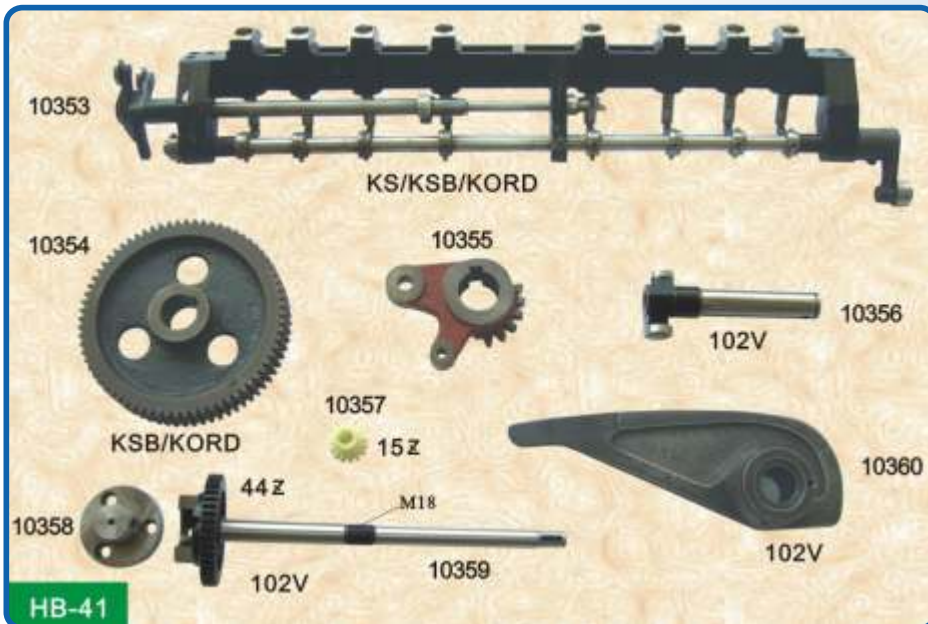
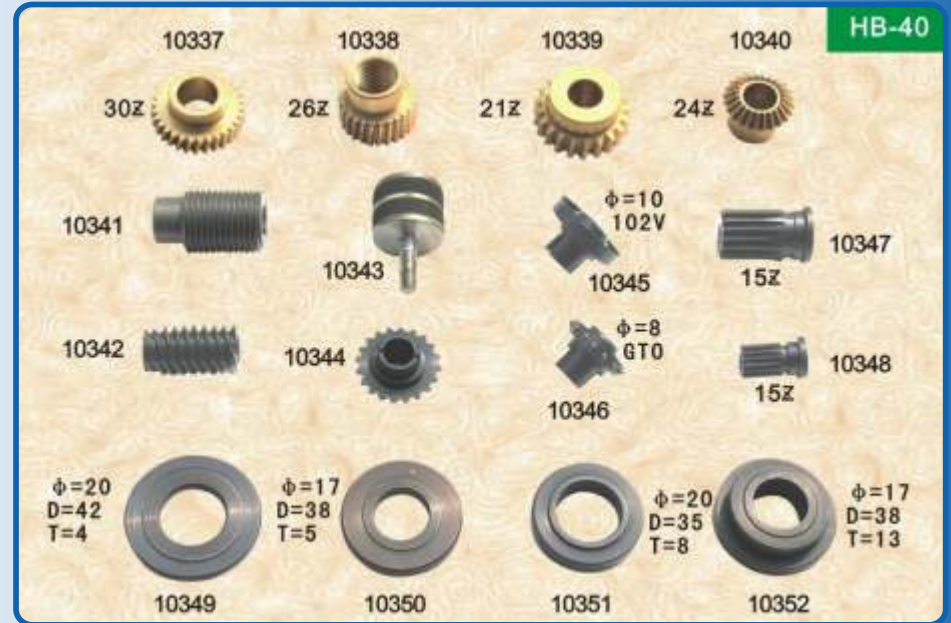
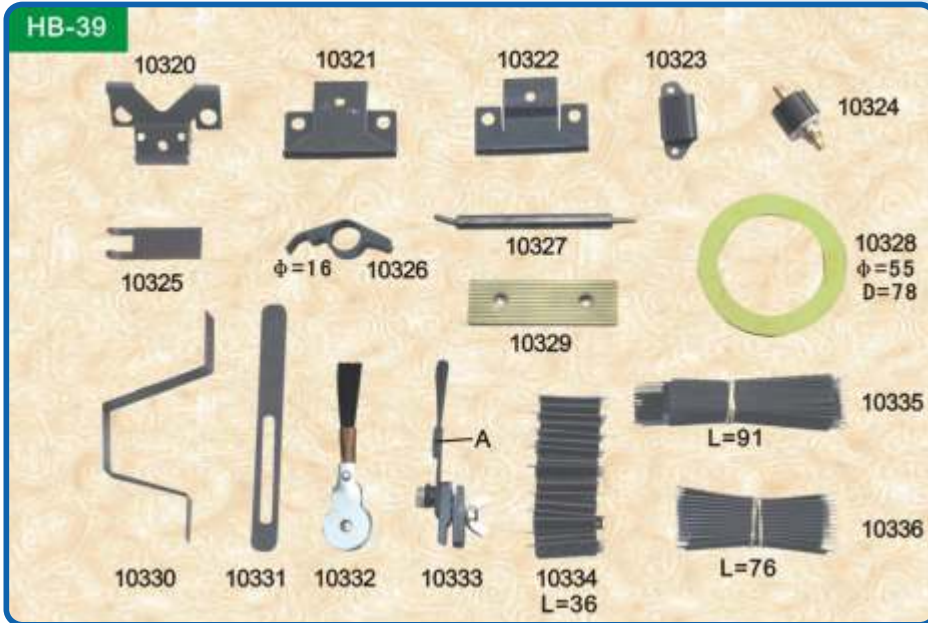

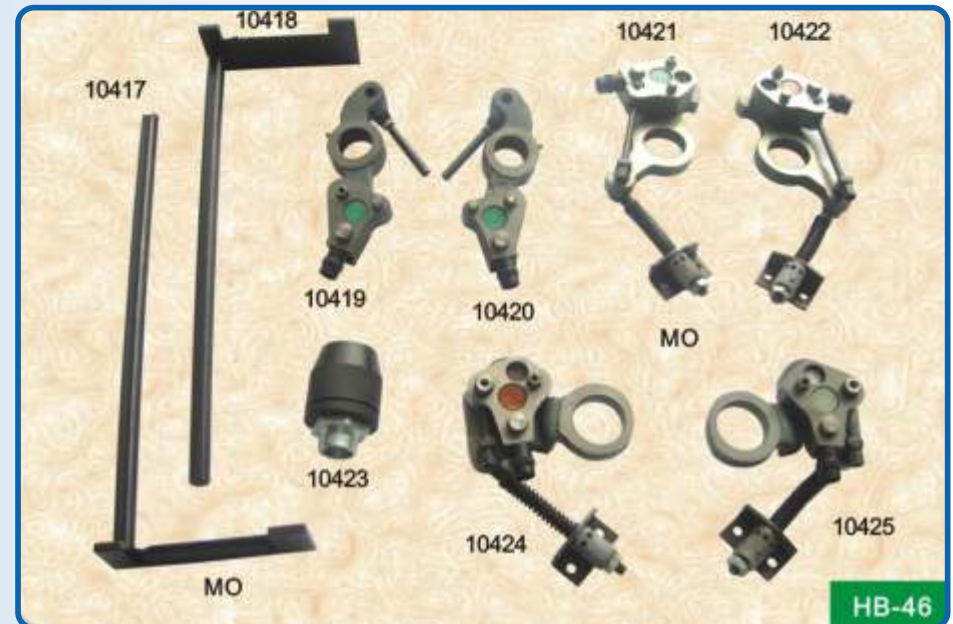

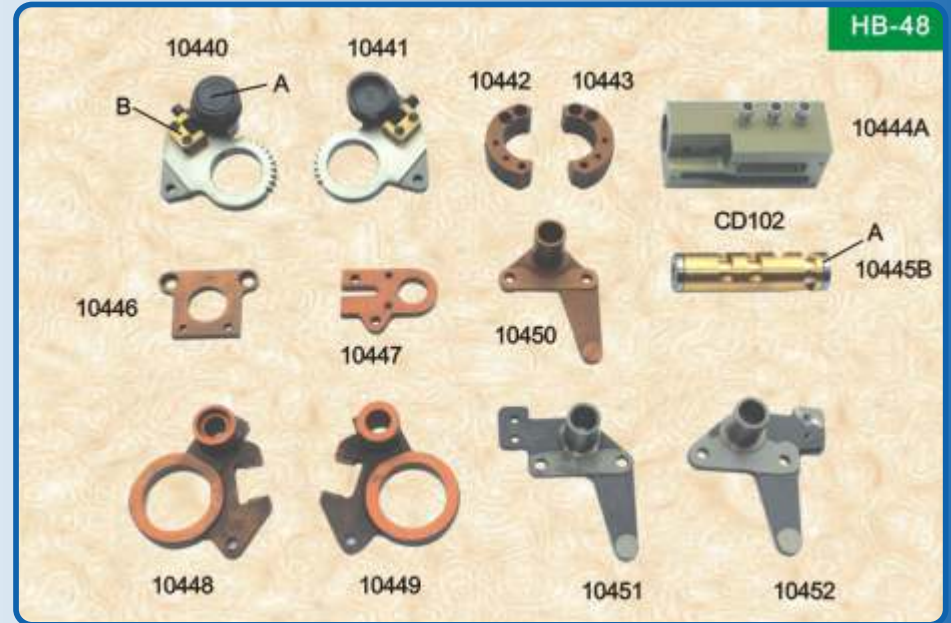
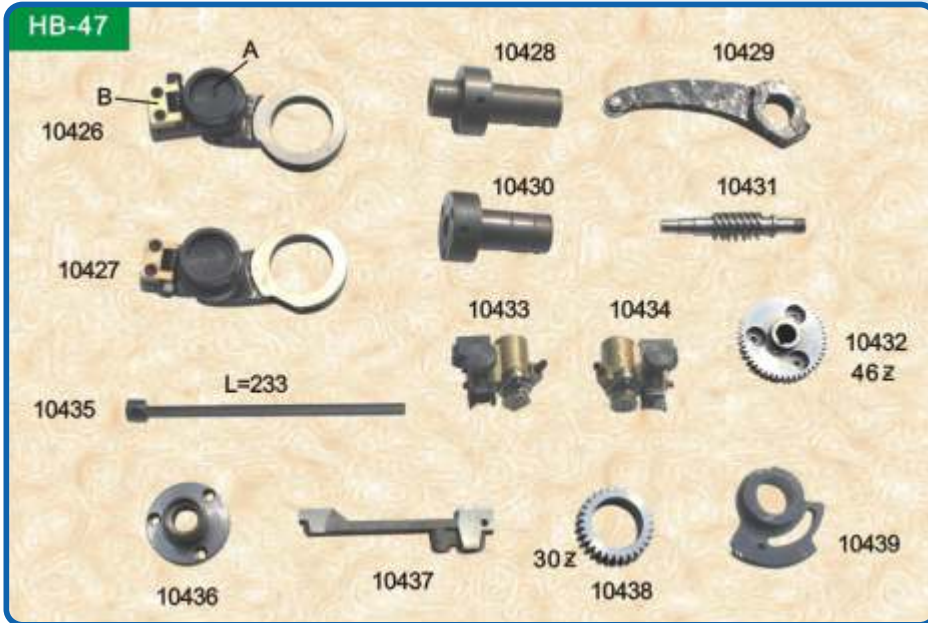



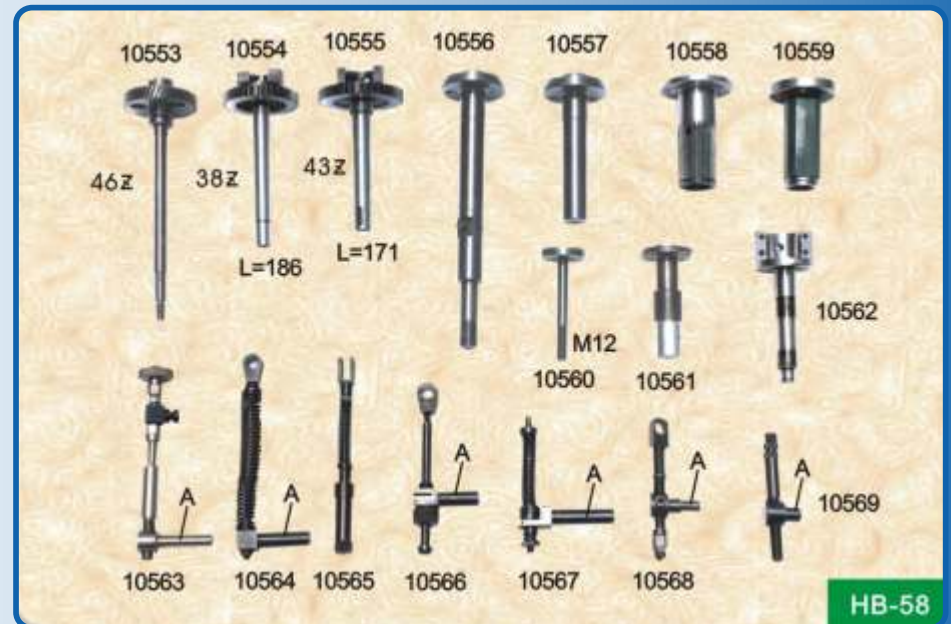
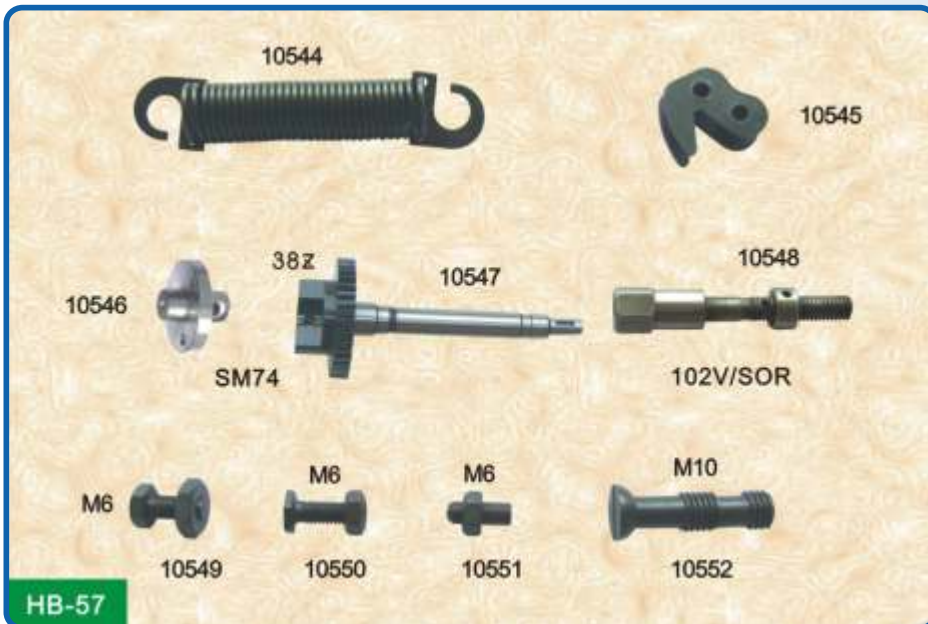

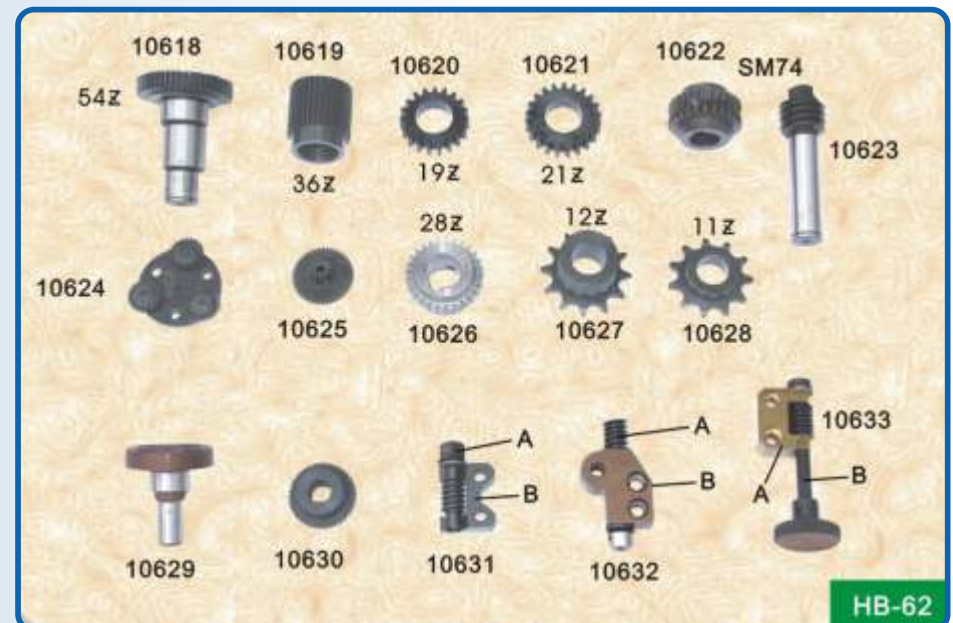
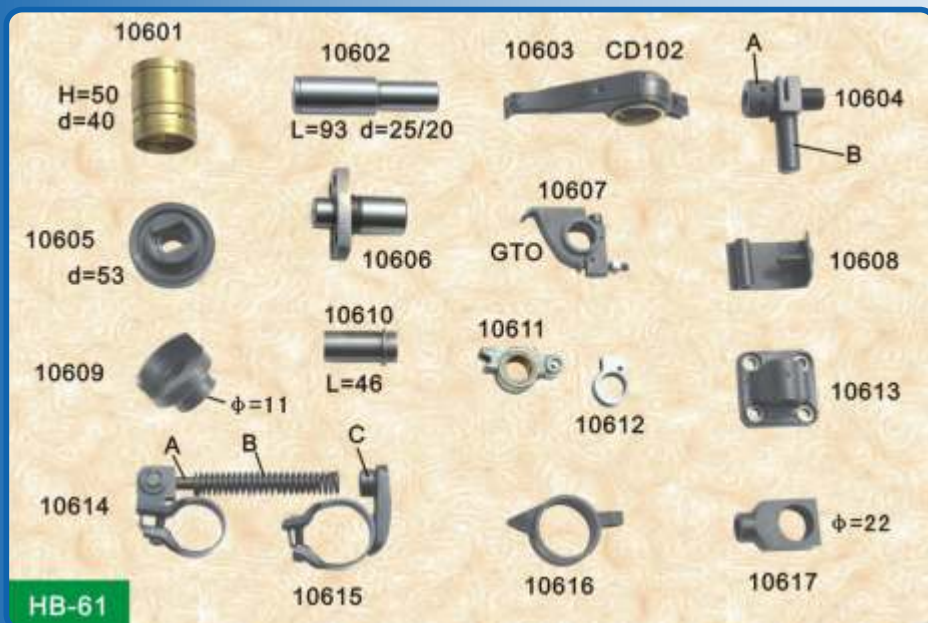
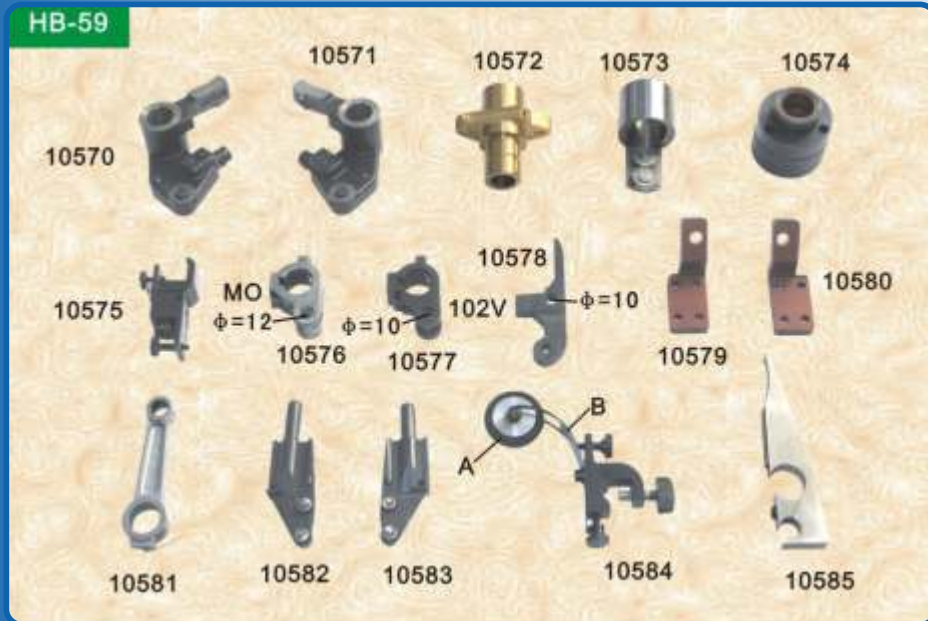



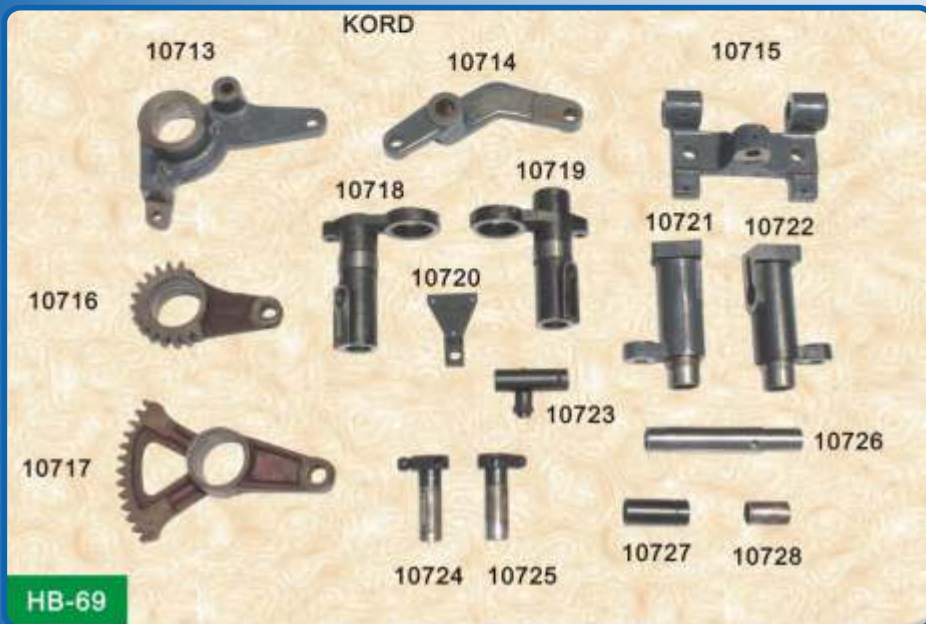

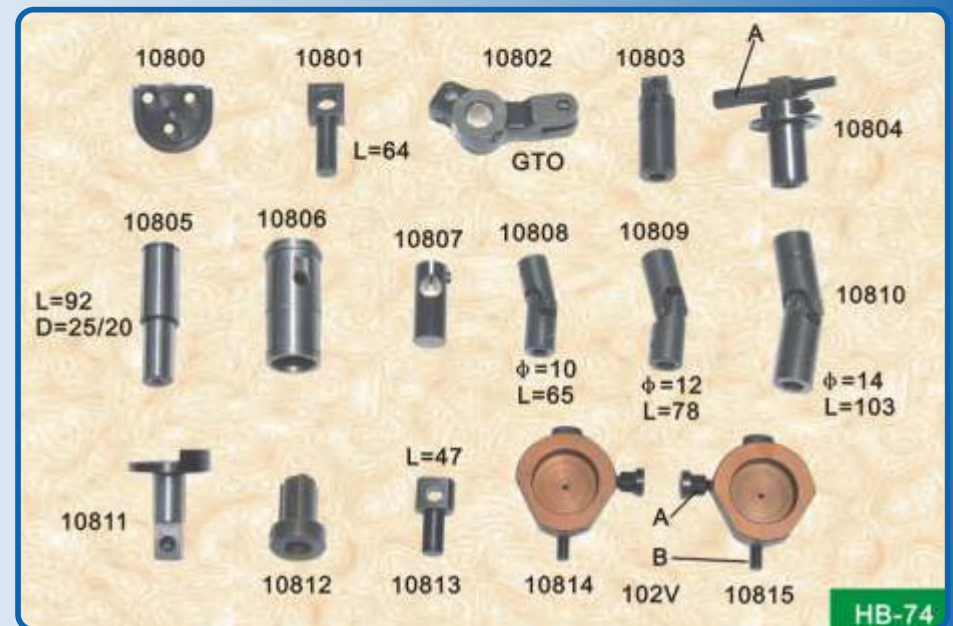
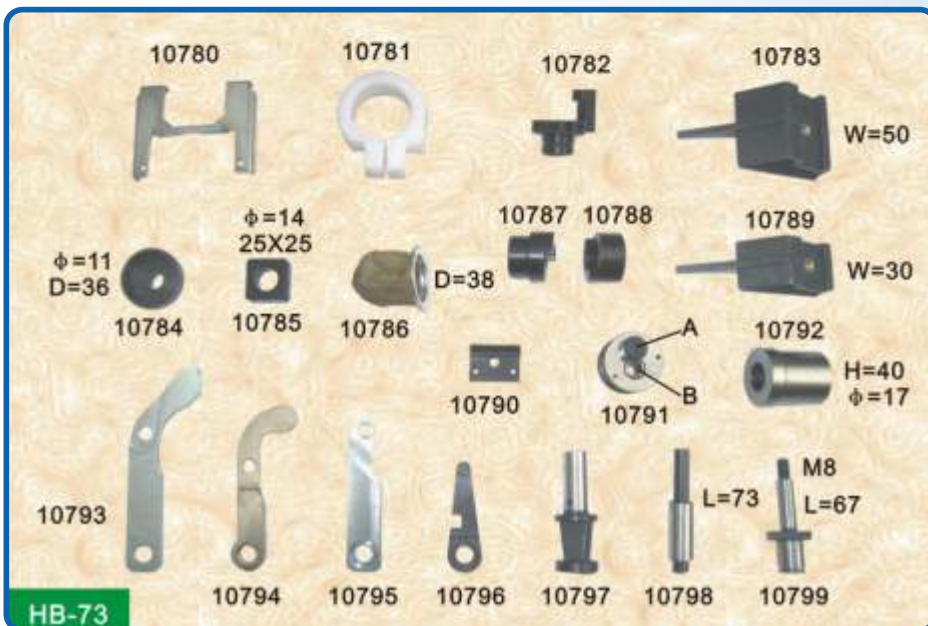
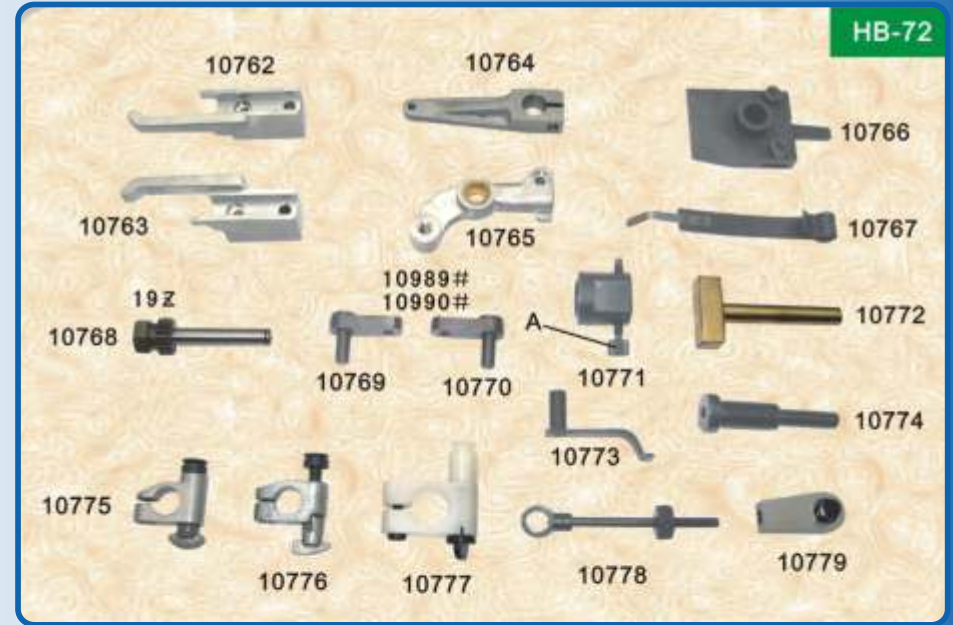

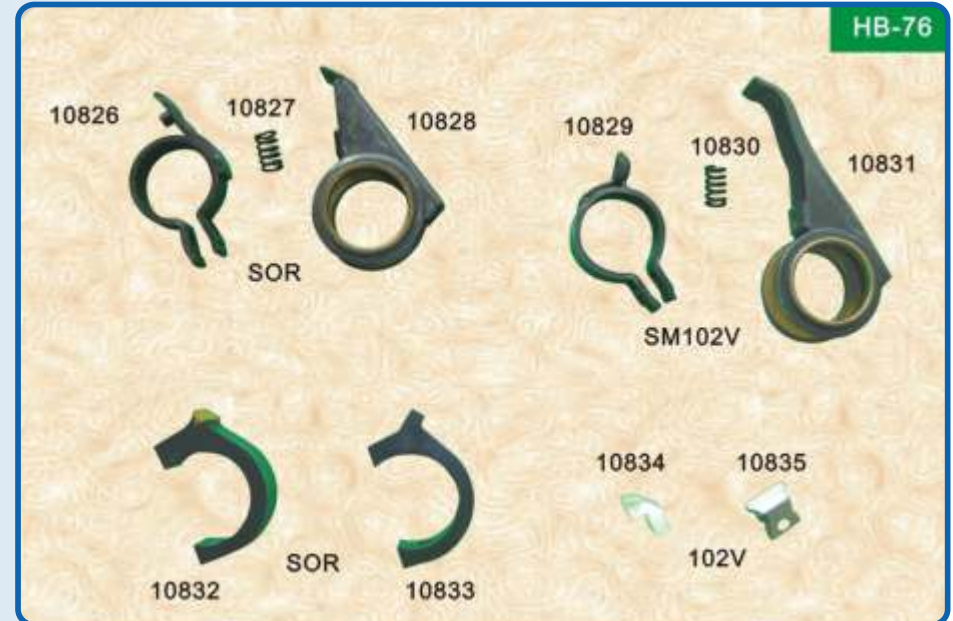
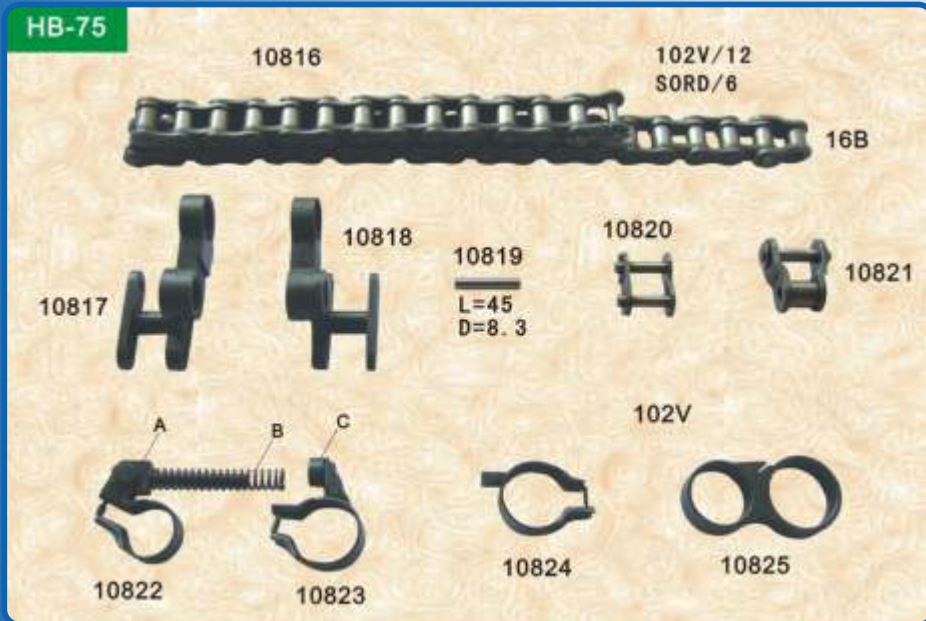

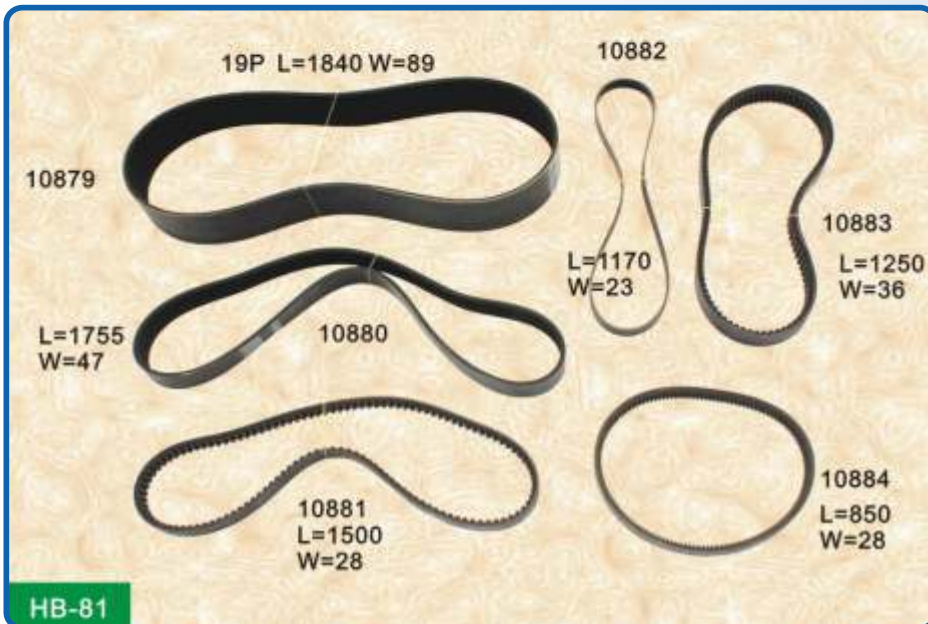
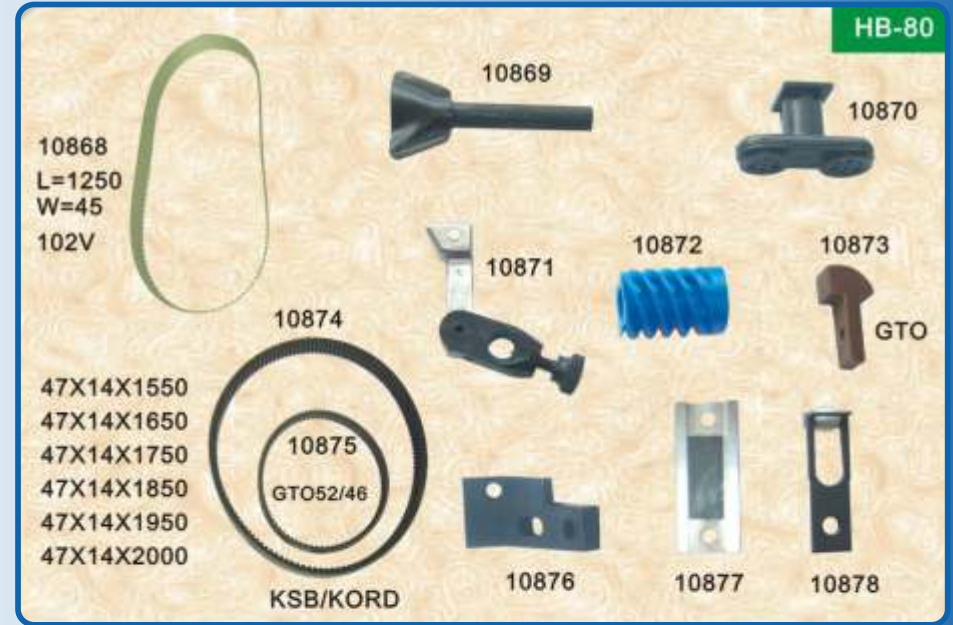

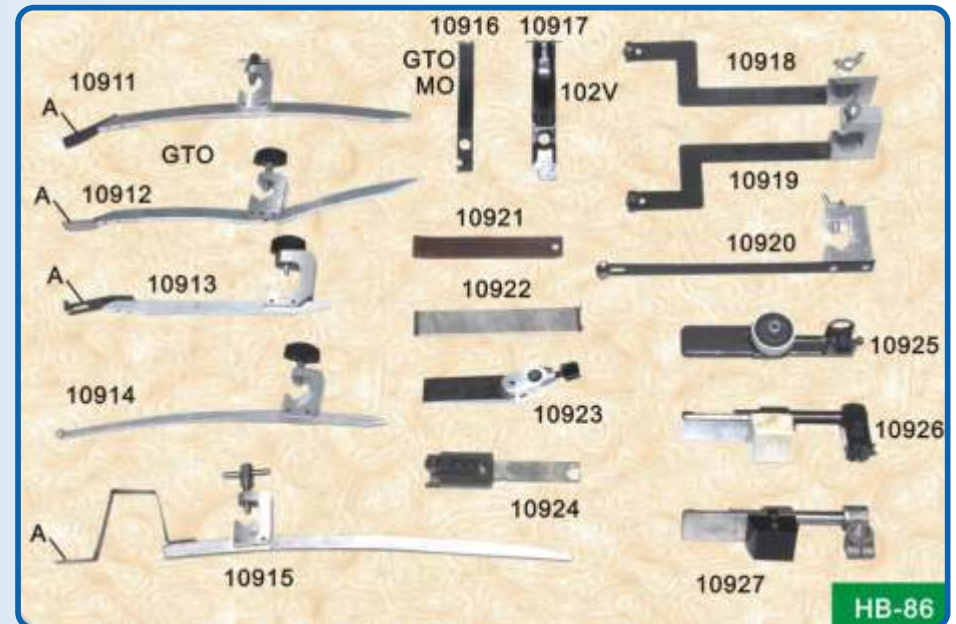
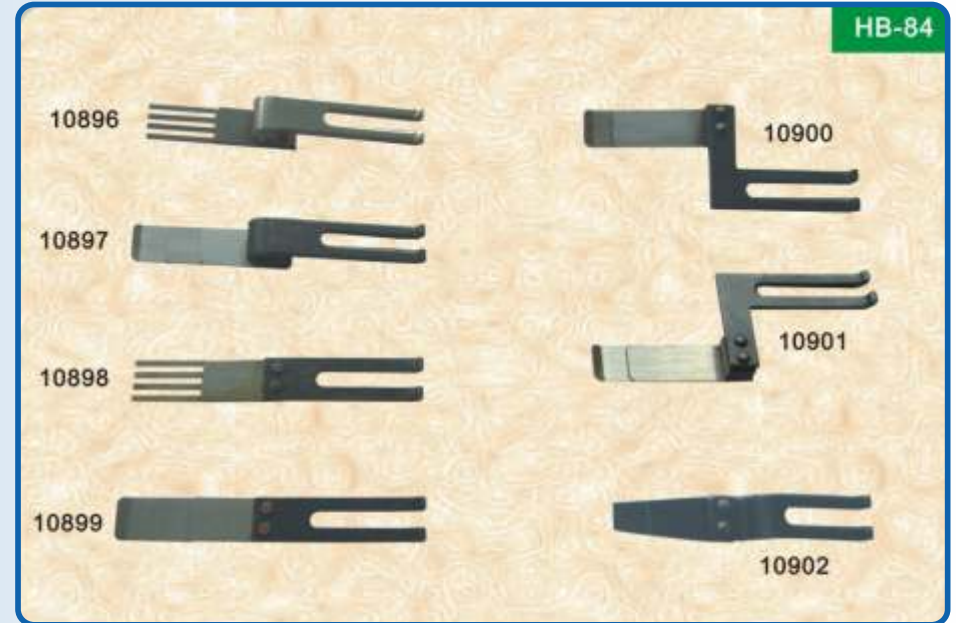
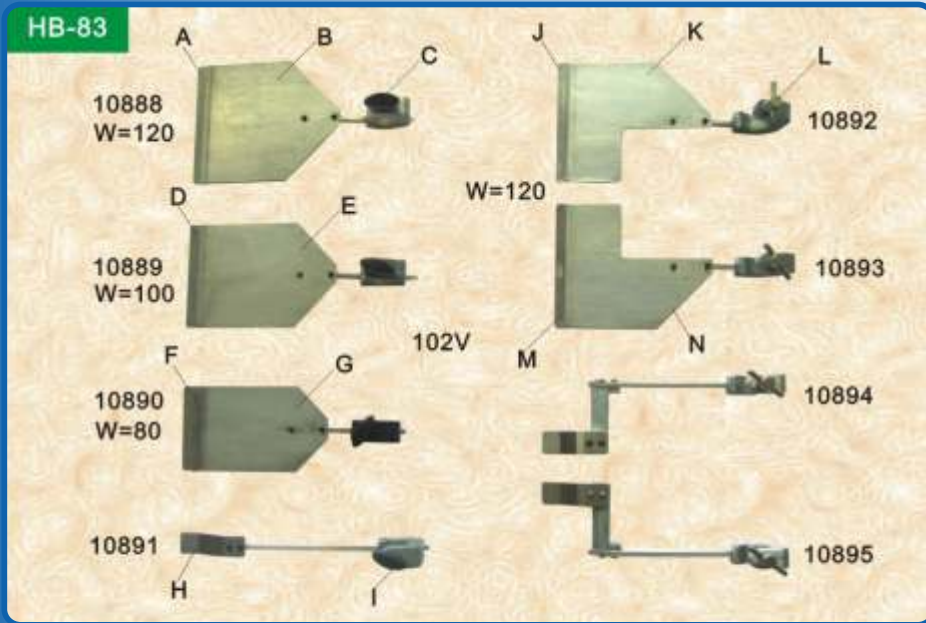

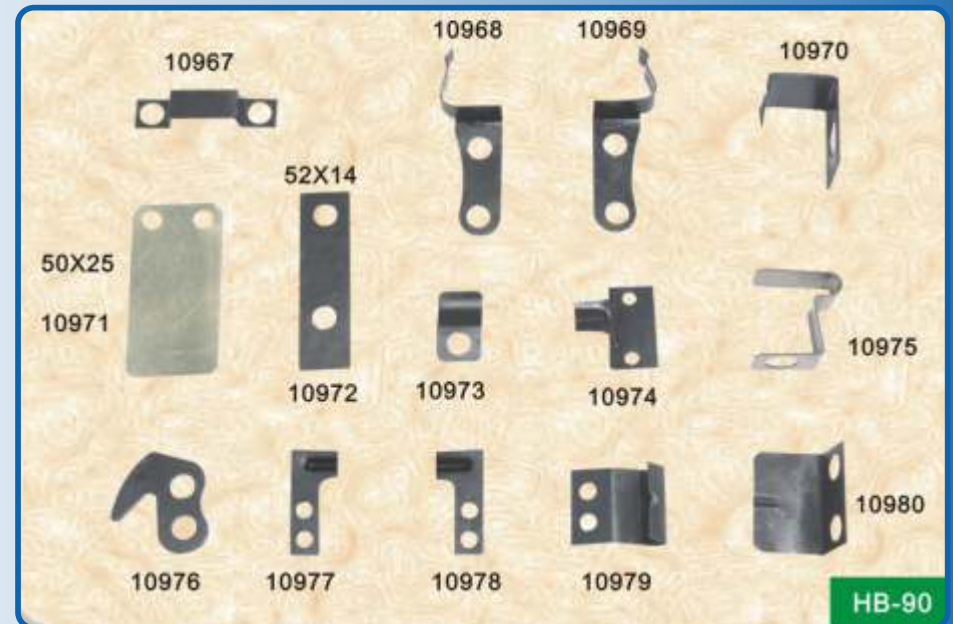
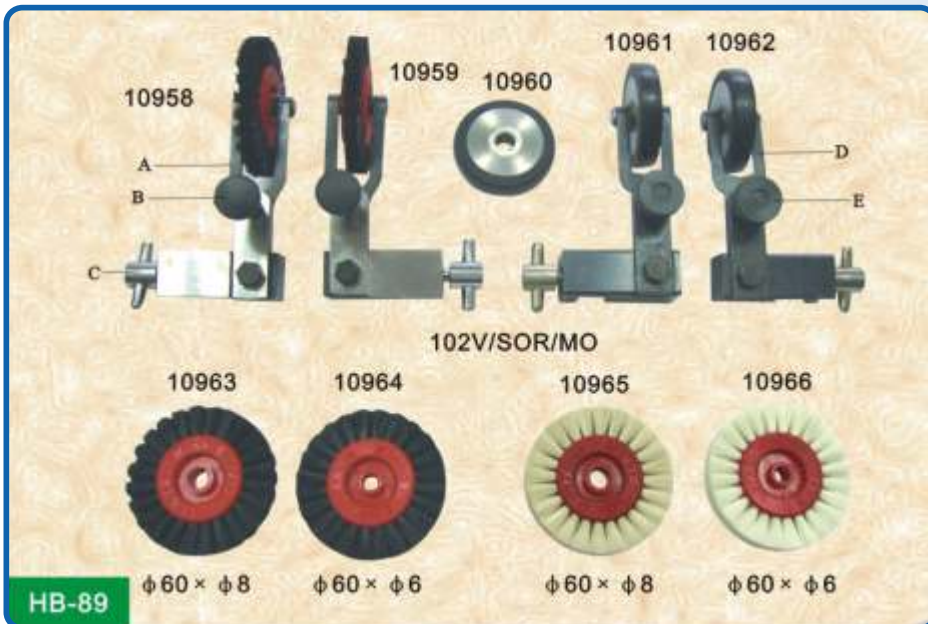
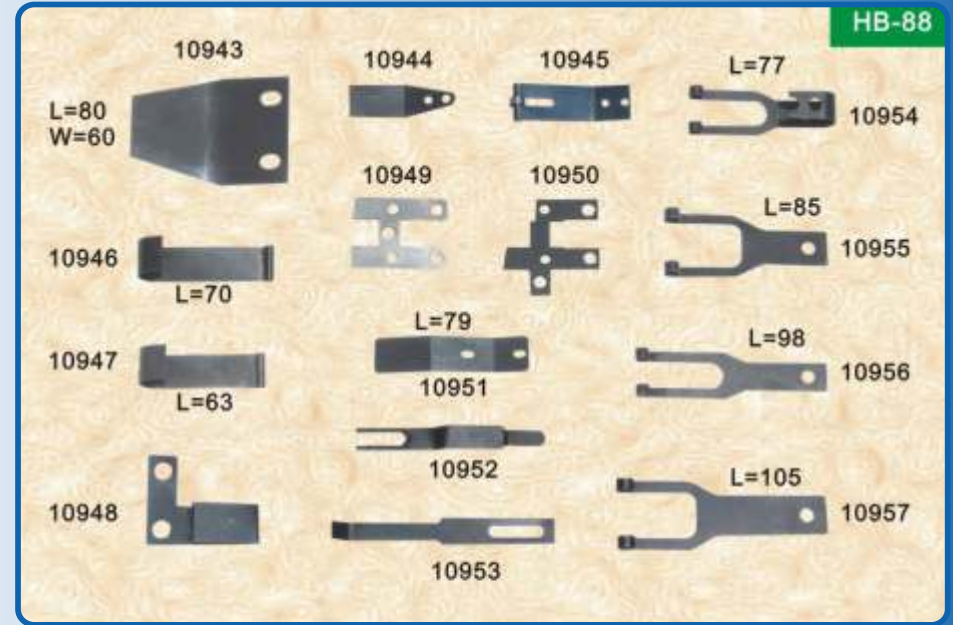
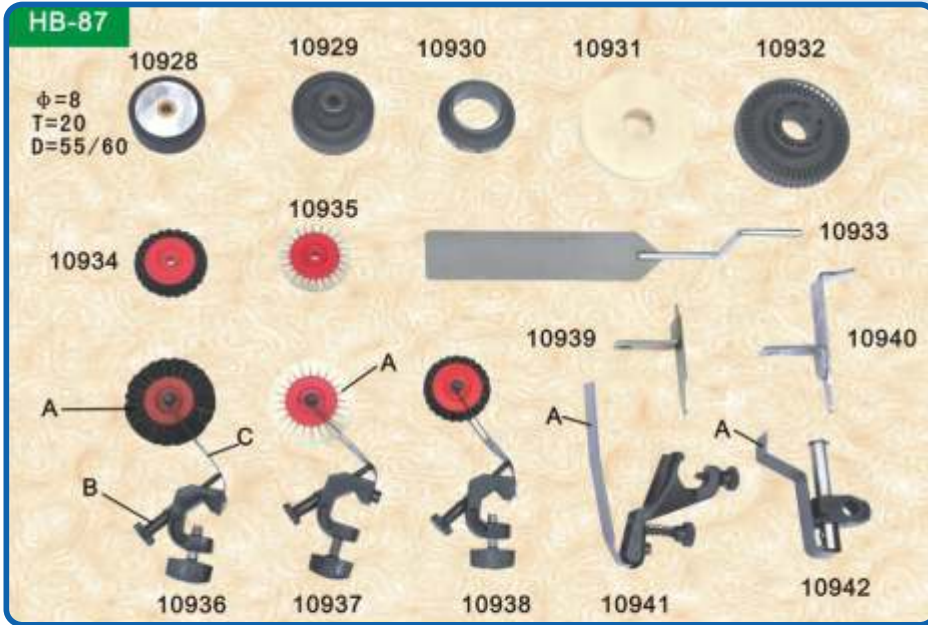

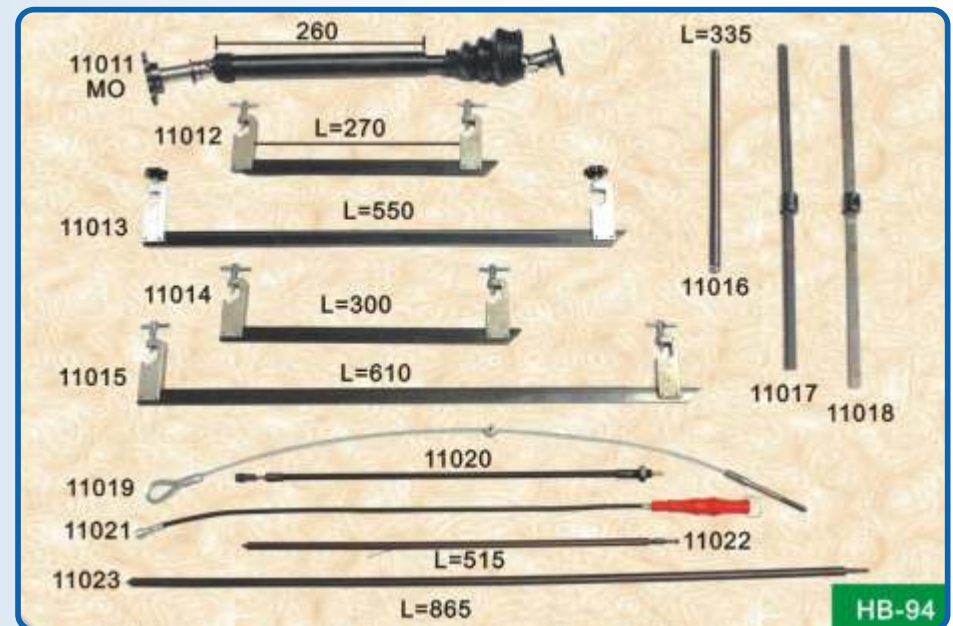
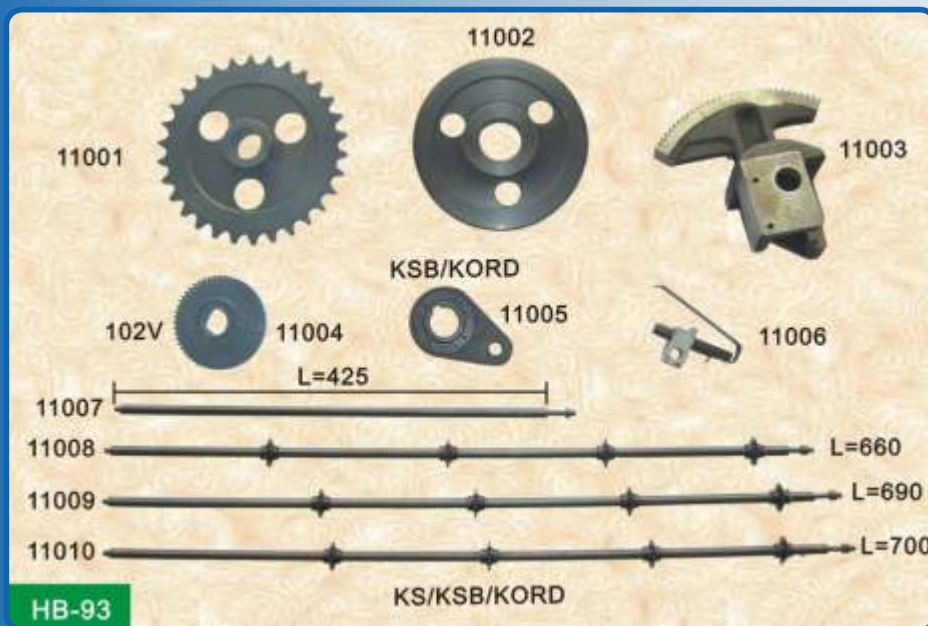
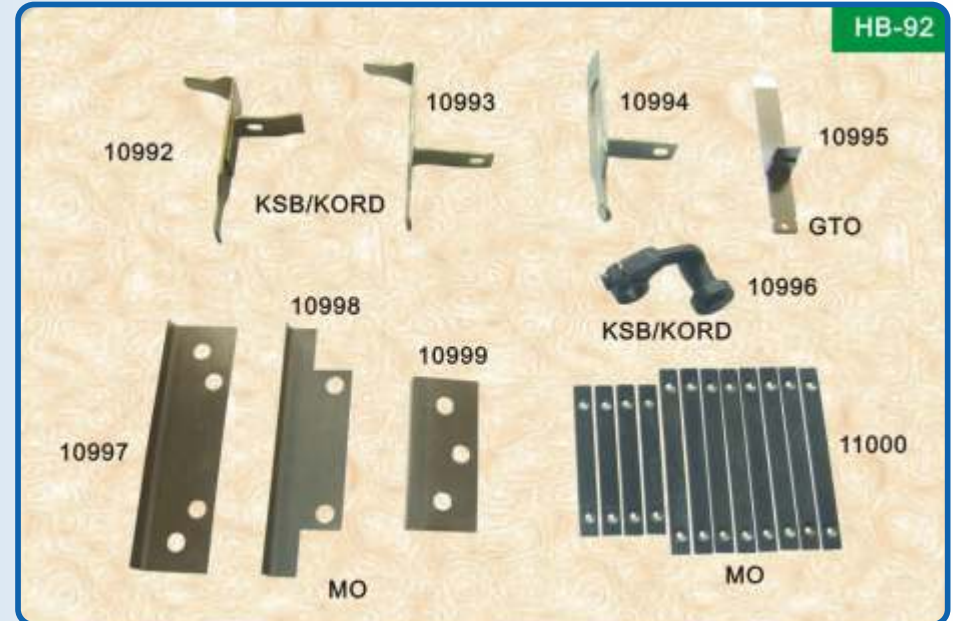
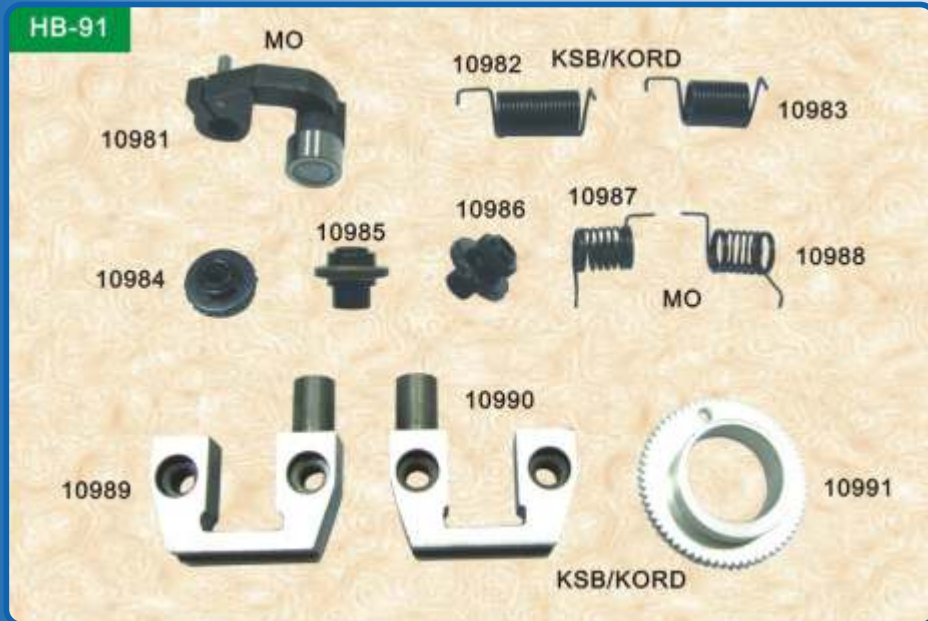

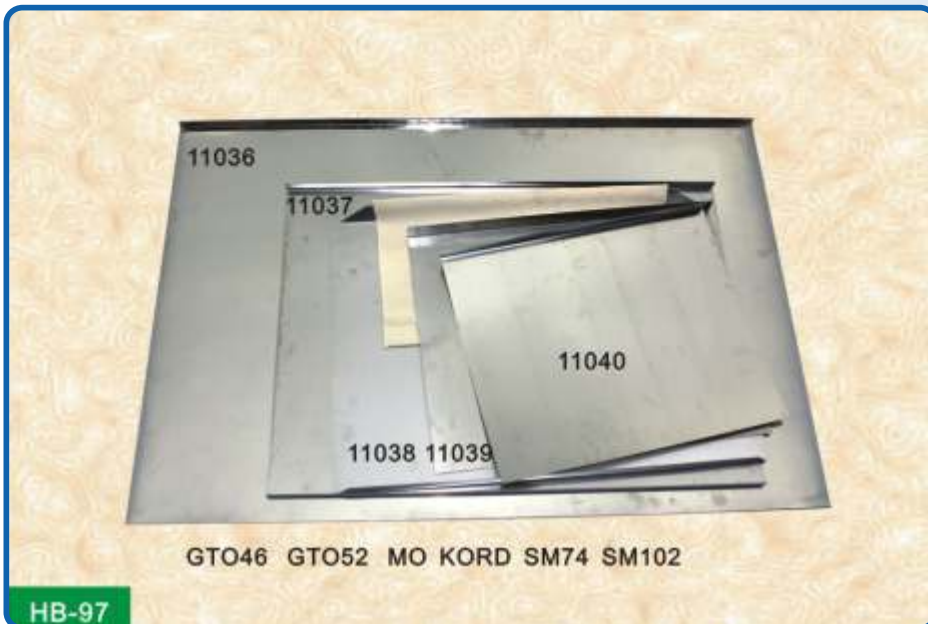
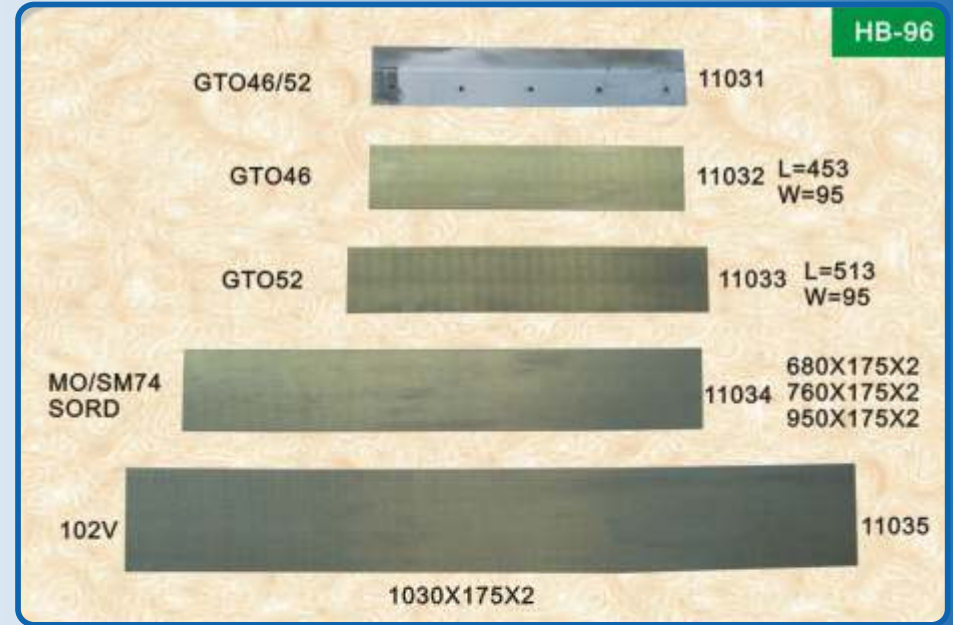
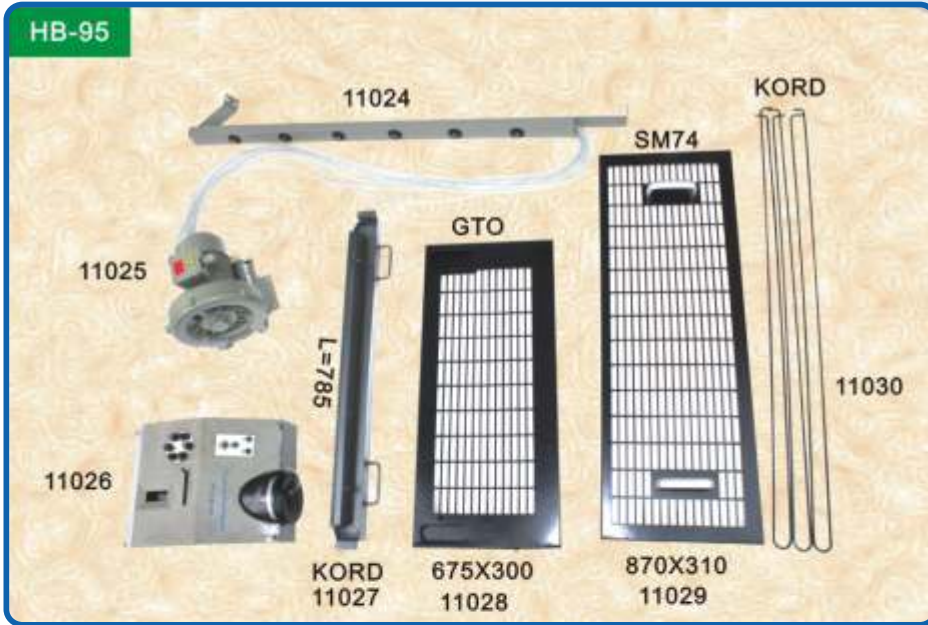

| NO. | MODEL | METAL THICKNESS | SIZE(cm) WIDTH | SIZE(cm) LENGTH |
|-----|----------------|-----------------|----------------|-----------------|
| 1 | PRINTMASTER 46 | 0.3 | 36 | 46 |
| 2 | PRINTMASTER 52 | 0.3 | 36 | 52 |
| 3 | GTO 46 | 0.3 | 32 | 46 |
| 4 | GTO 52 | 0.3 | 36 | 52 |
| 5 | SM 52 | 0.3 | 36 | 52 |
| 6 | MO65 | 0.3 | 48 | 65 |
| 7 | SM72 | 0.3 | 52 | 72 |
| 8 | SM74 | 0.3 | 52 | 74 |
| 9 | SM102 | 0.3 | 72 | 102 |
| 10 | KOR | 0.6 | 40 | 57 |
| 11 | KORA57 | 0.6 | 46 | 57 |
| 12 | KORD 62 | 0.6 | 46 | 62 |
| 13 | KORD 64 | 0.6 | 46 | 64 |
| 14 | KORS 72 | 0.6 | 52 | 72 |
| 15 | KS | 0.6 | 38 | 52 |
| 16 | KSB | 0.6 | 40 | 57 |
| 17 | KSBA | 0.6 | 46 | 58.5 |
| 18 | KSBAZ | 0.6 | 46 | 57 |
| 19 | KSD | 0.6 | 46 | 64 |
| 20 | S(OHZ) | 0.6 | 54 | 72 |
| 21 | SB-SBG | 0.6 | 56 | 77 |
| 22 | SBG | 0.6 | 54 | 77 |
| 23 | SBB | 0.6 | 57 | 82 |
| 24 | SBD | 0.6 | 64 | 90 |
| 25 | SBD(SPECIAL) | 0.6 | 64 | 89 |

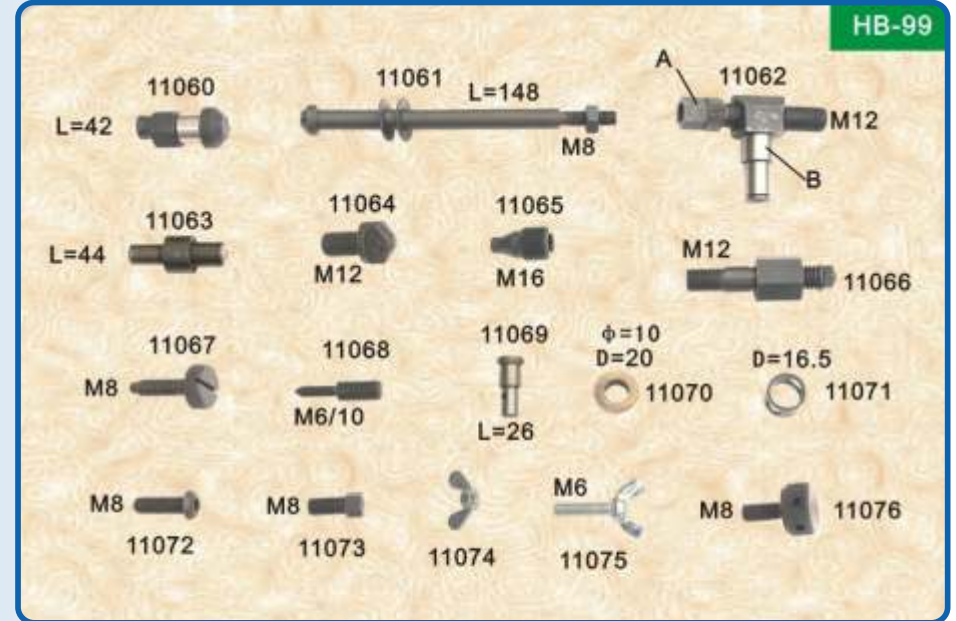
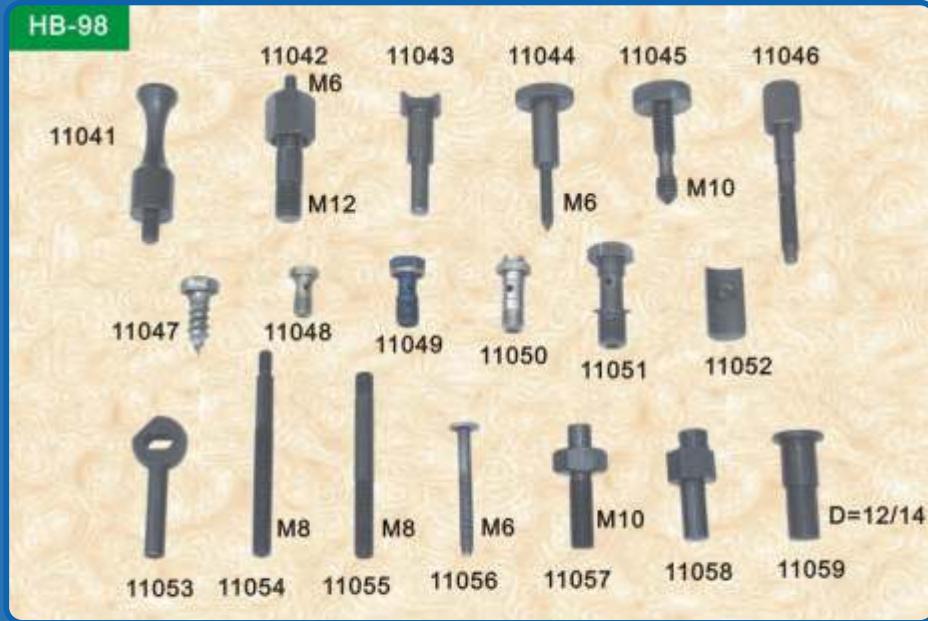

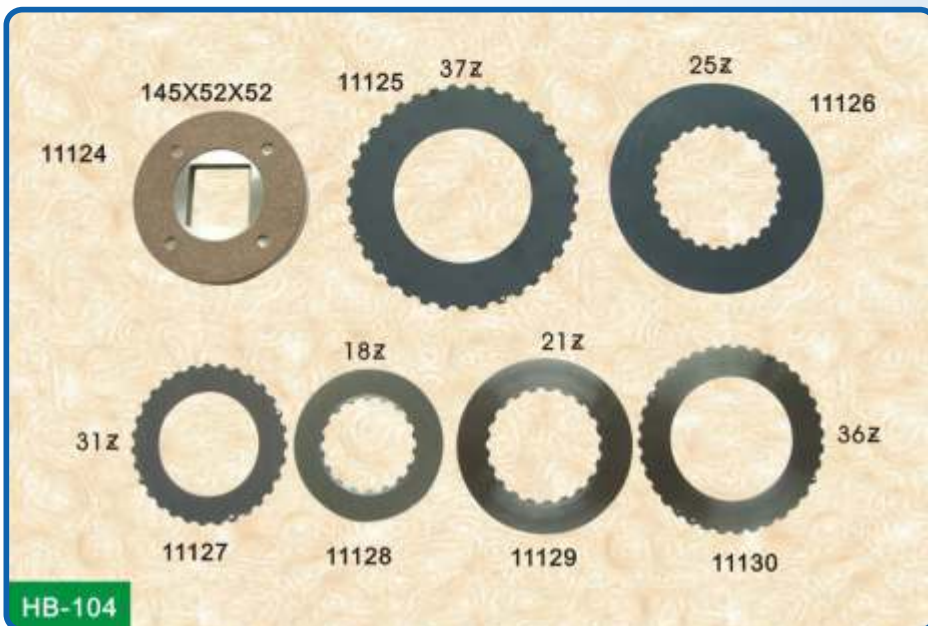

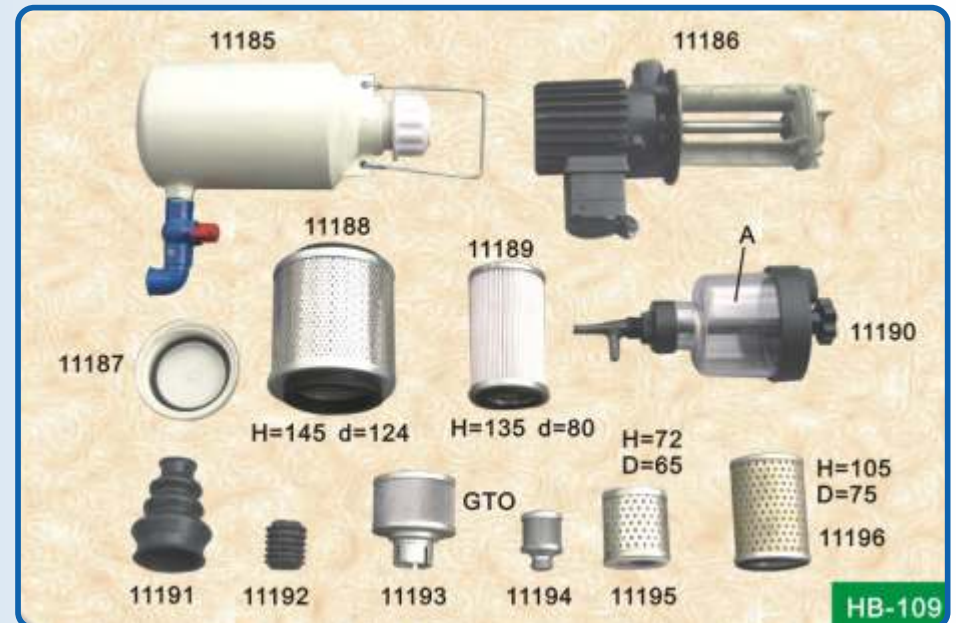
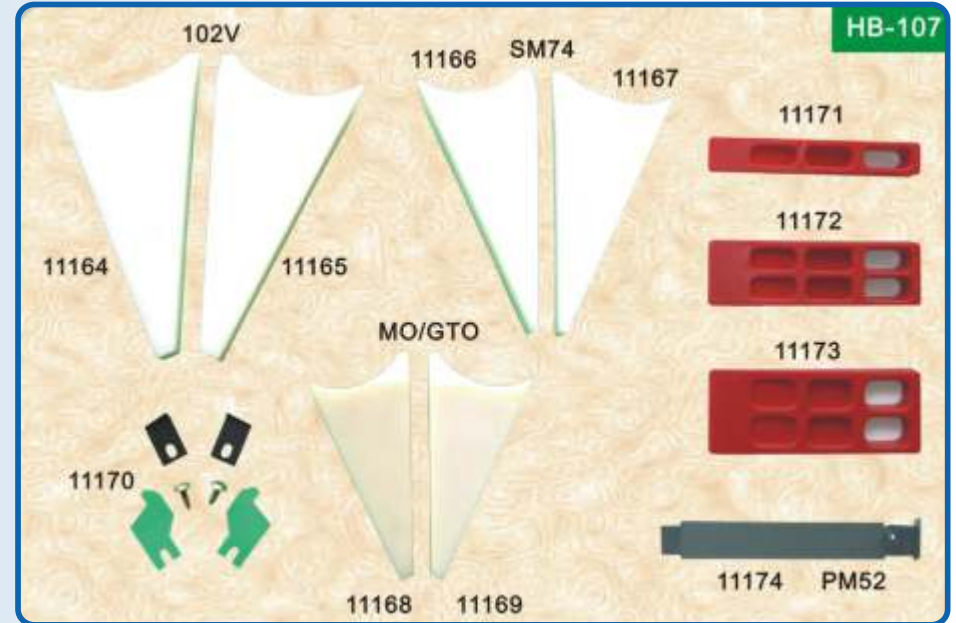
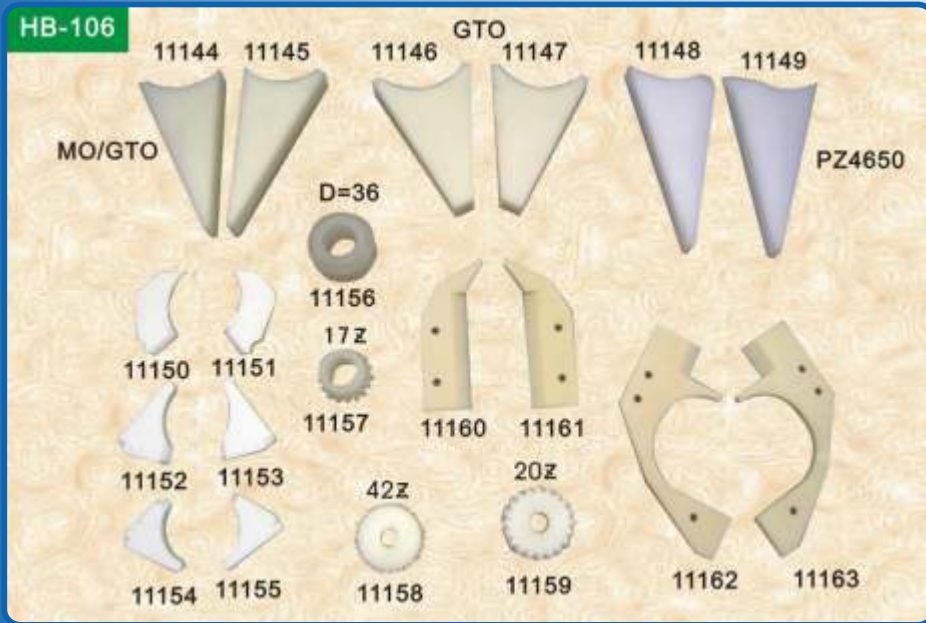

Heidelberg



Contacto: 55-5601-0265 / 55-5604-5904 / 55-5534-1708

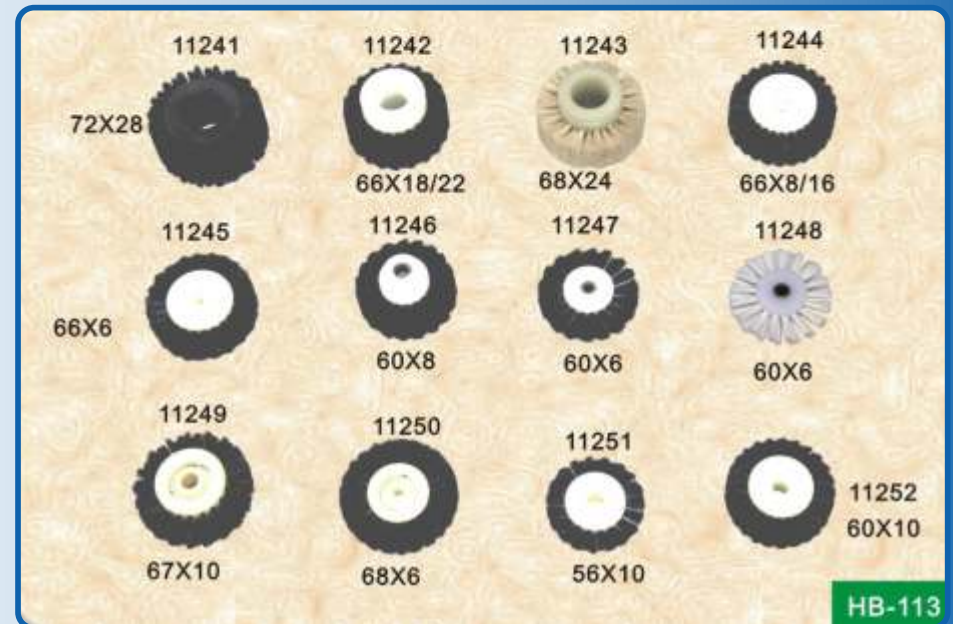
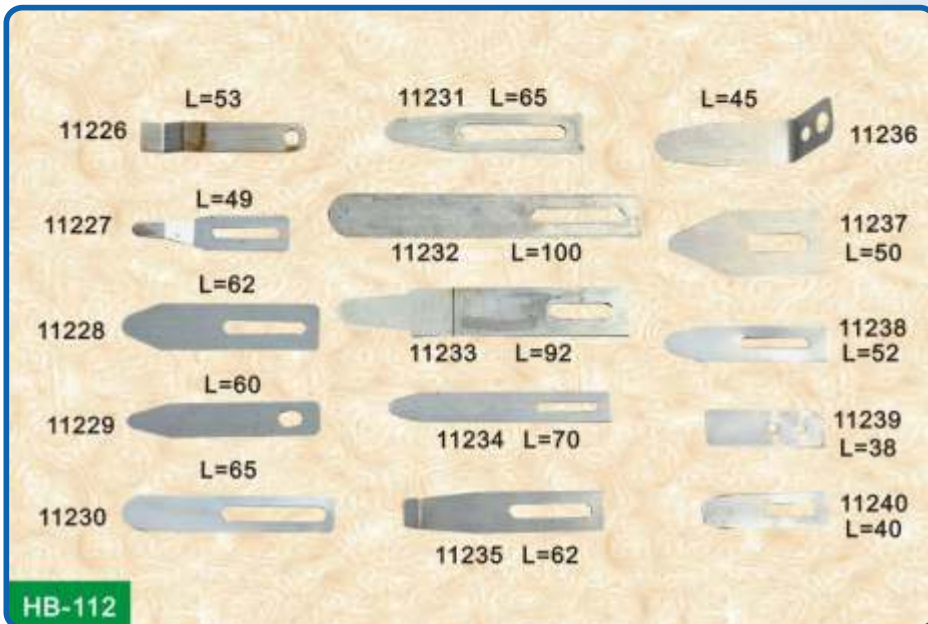
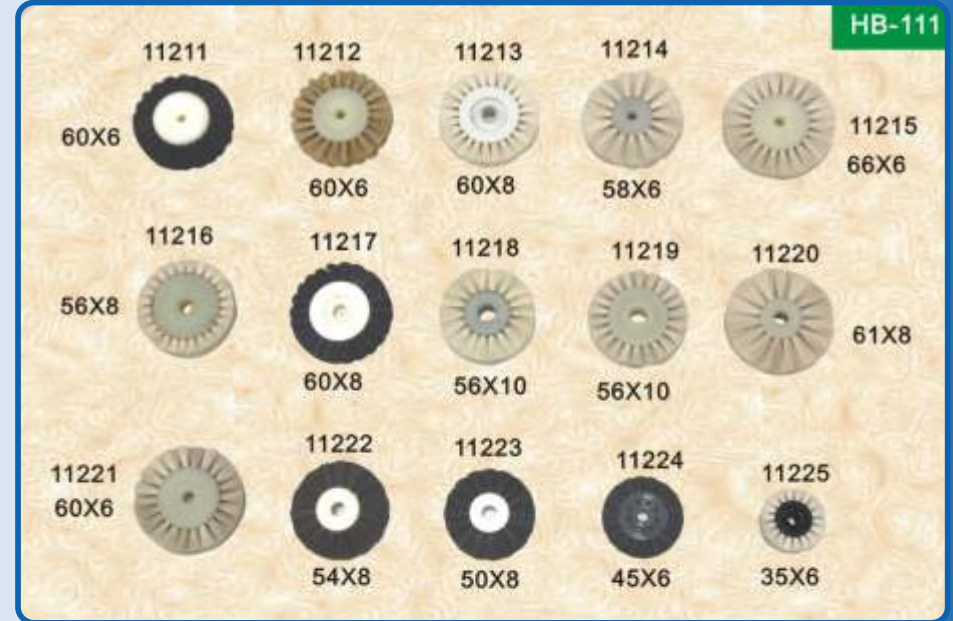

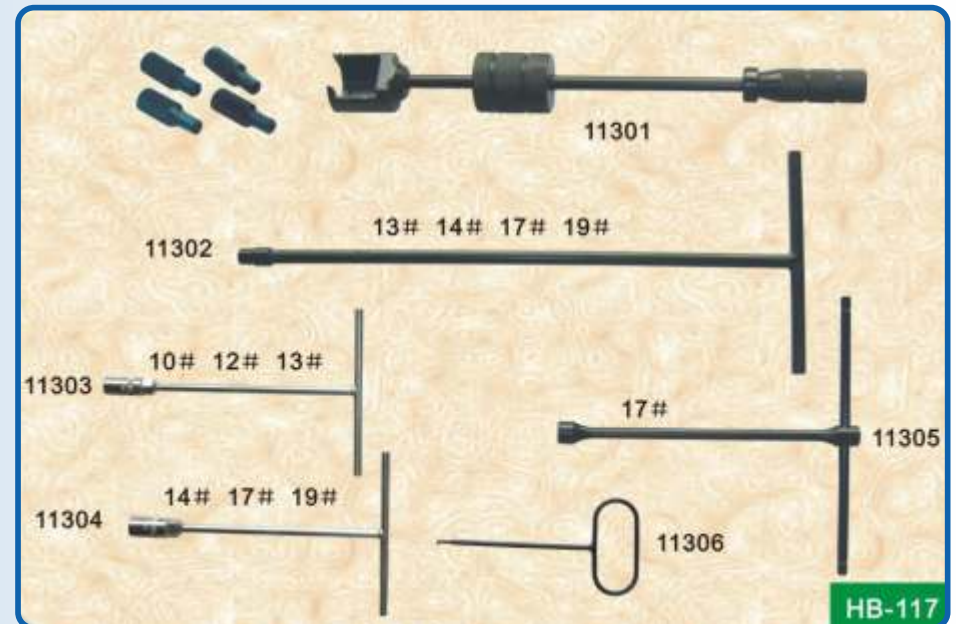
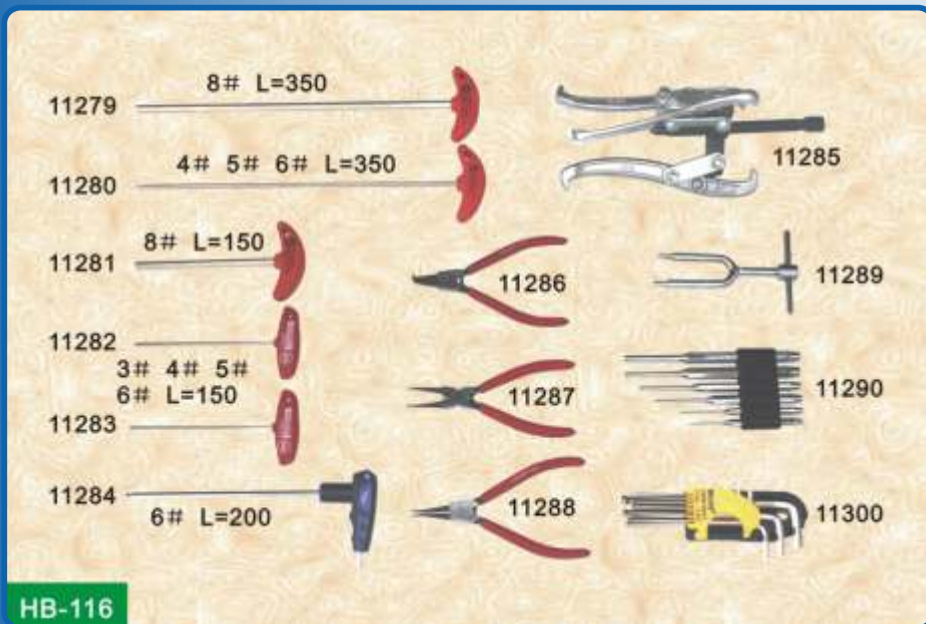
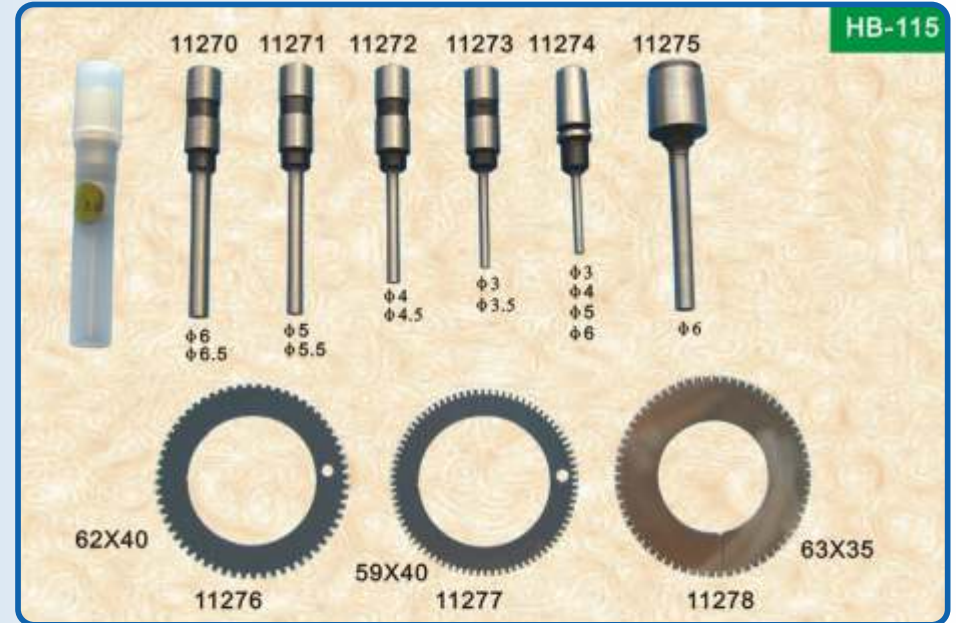
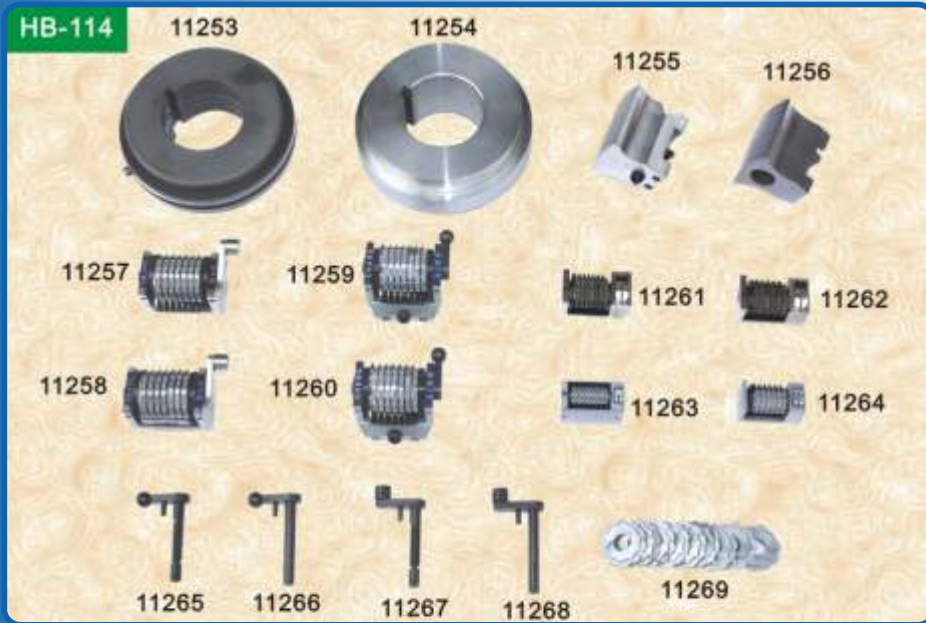

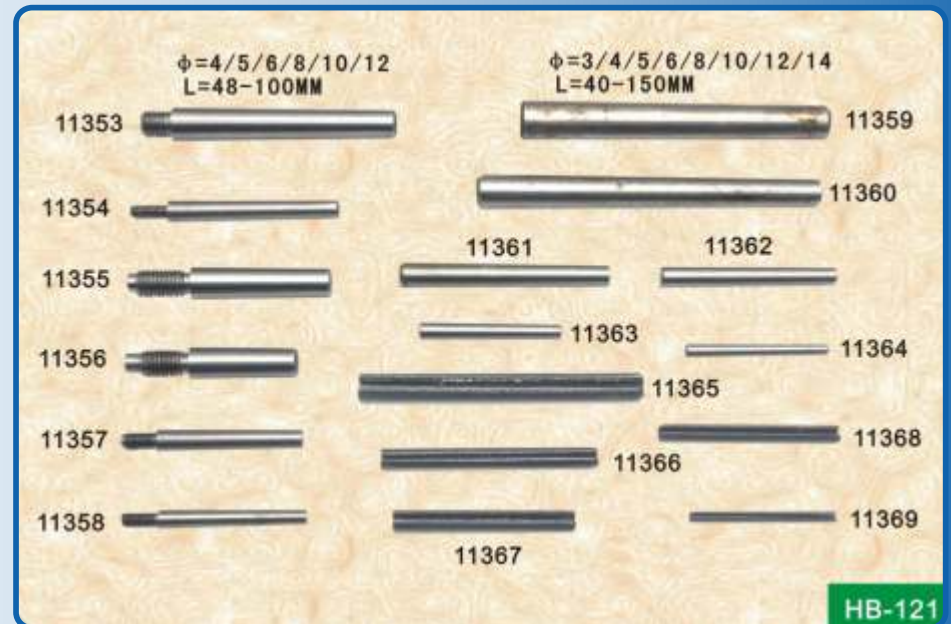
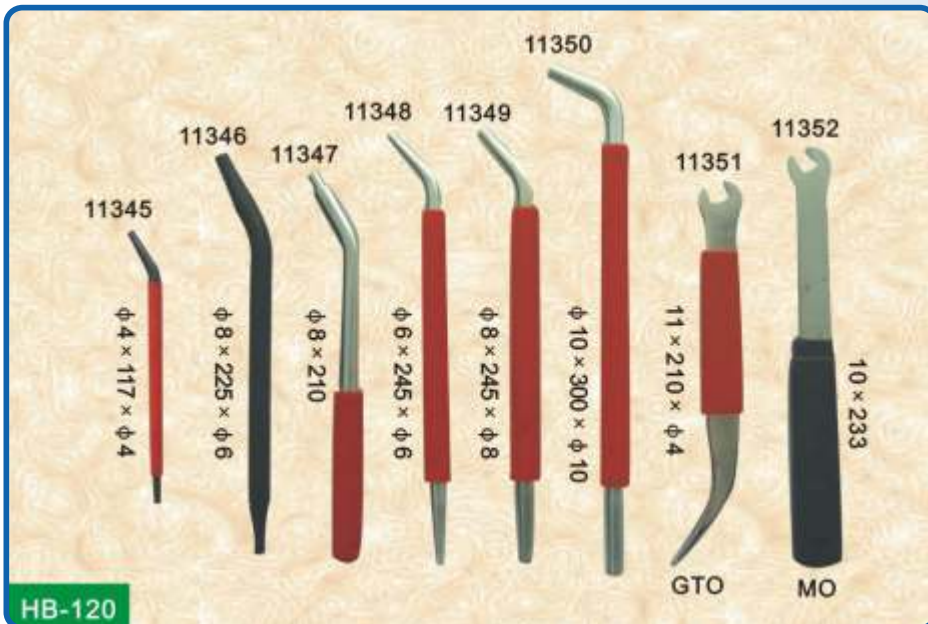
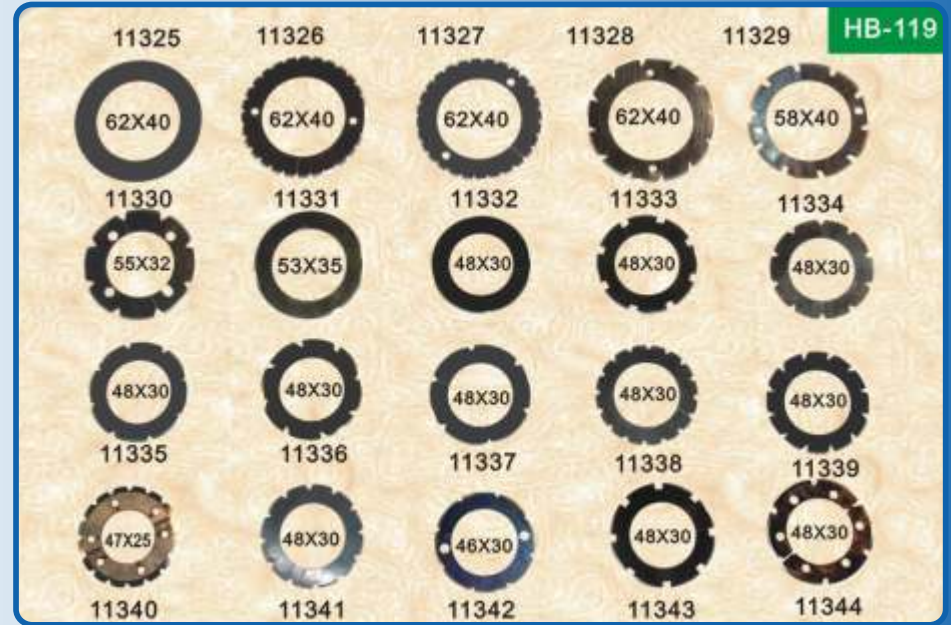
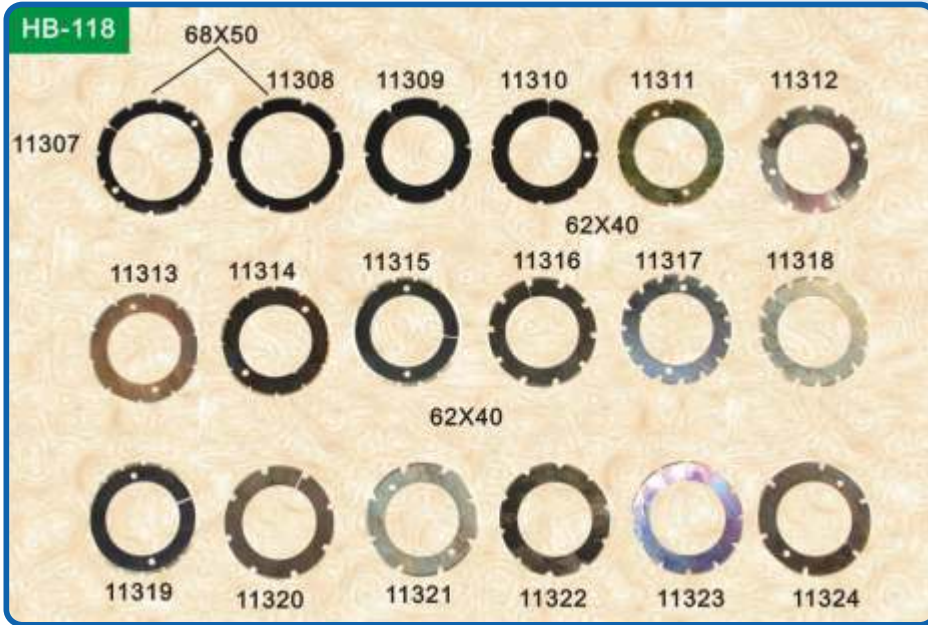

HB-122

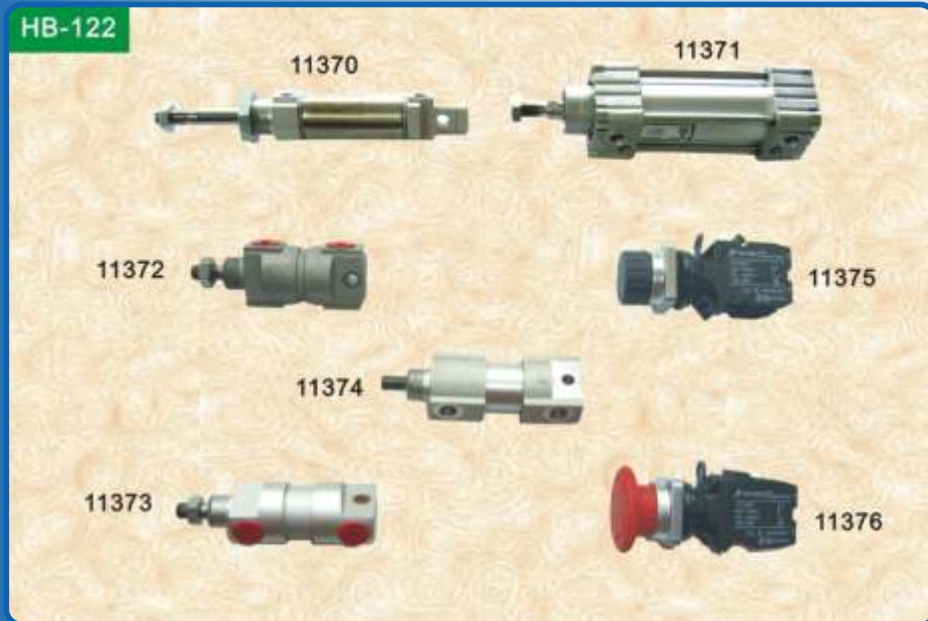

HB-123



HB-124



HB-125



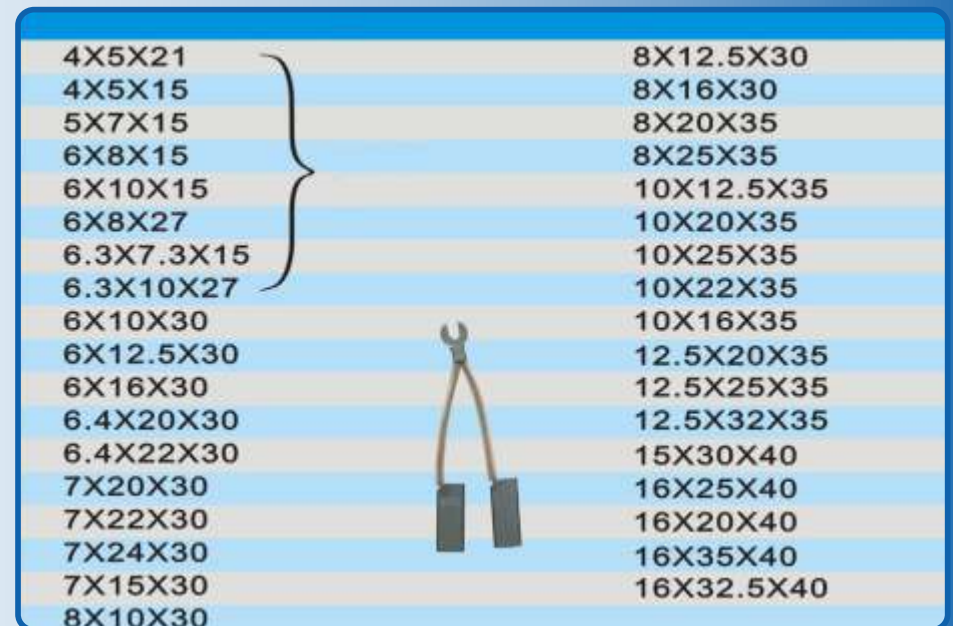
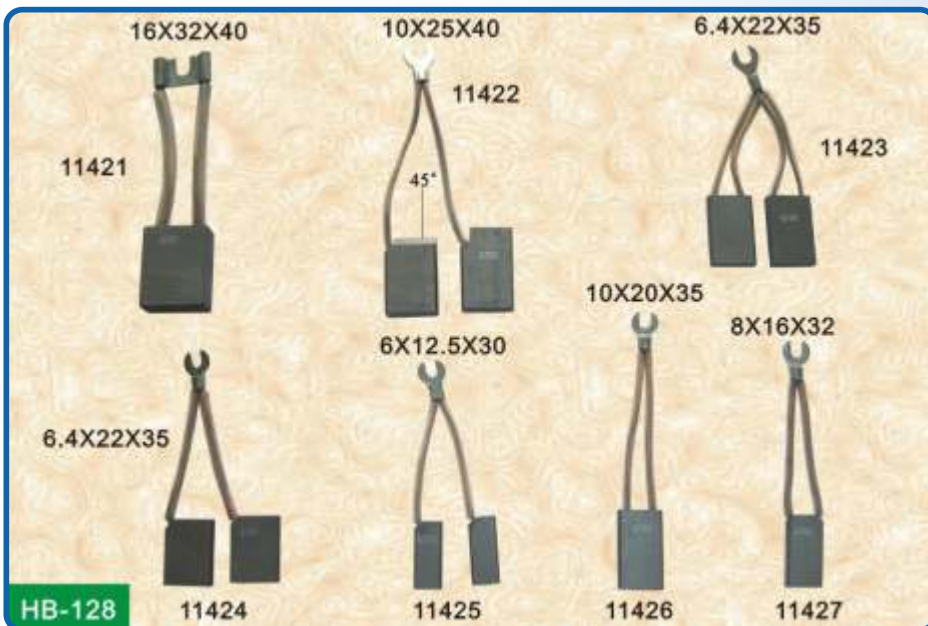
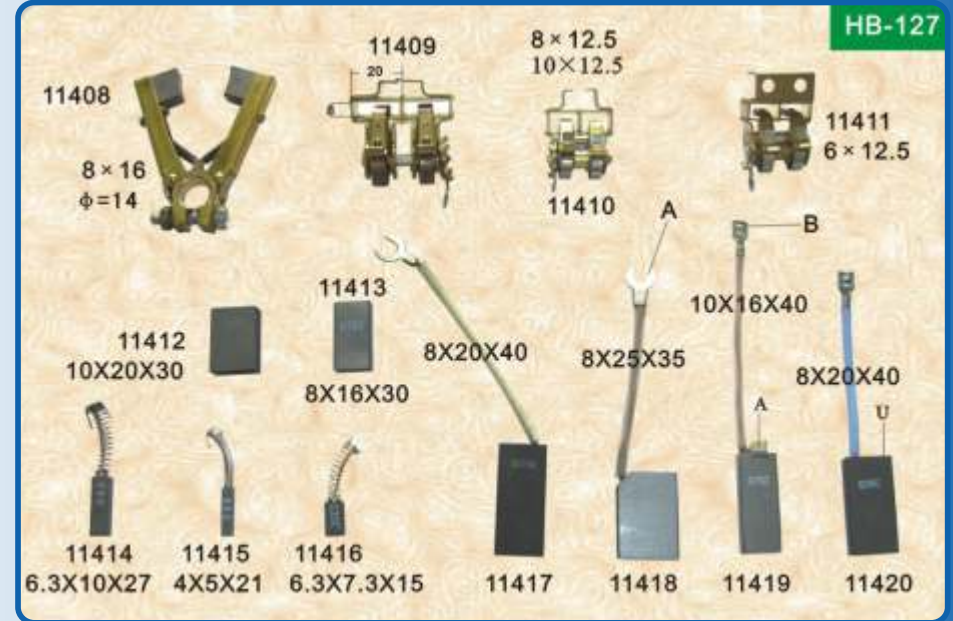
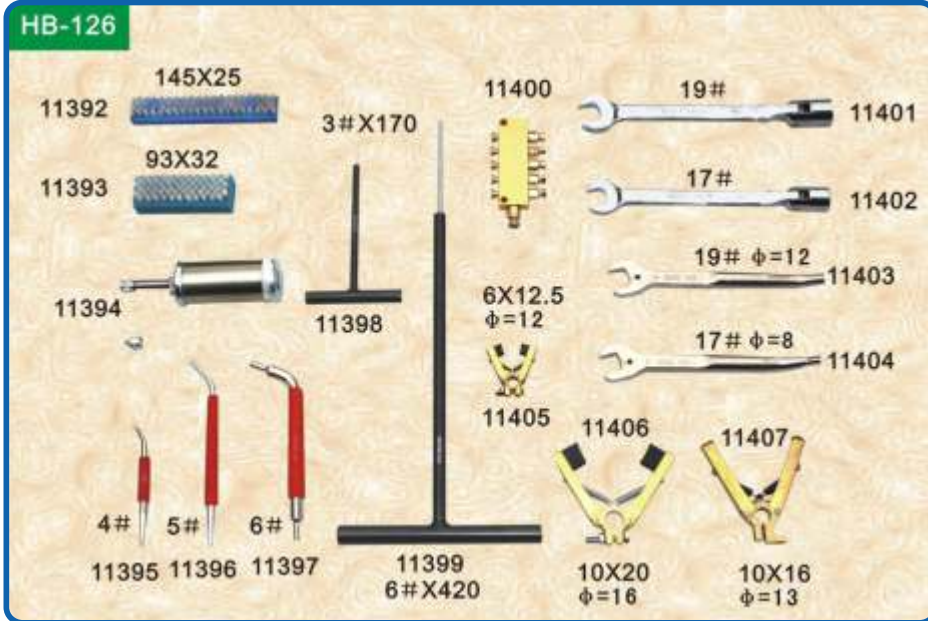

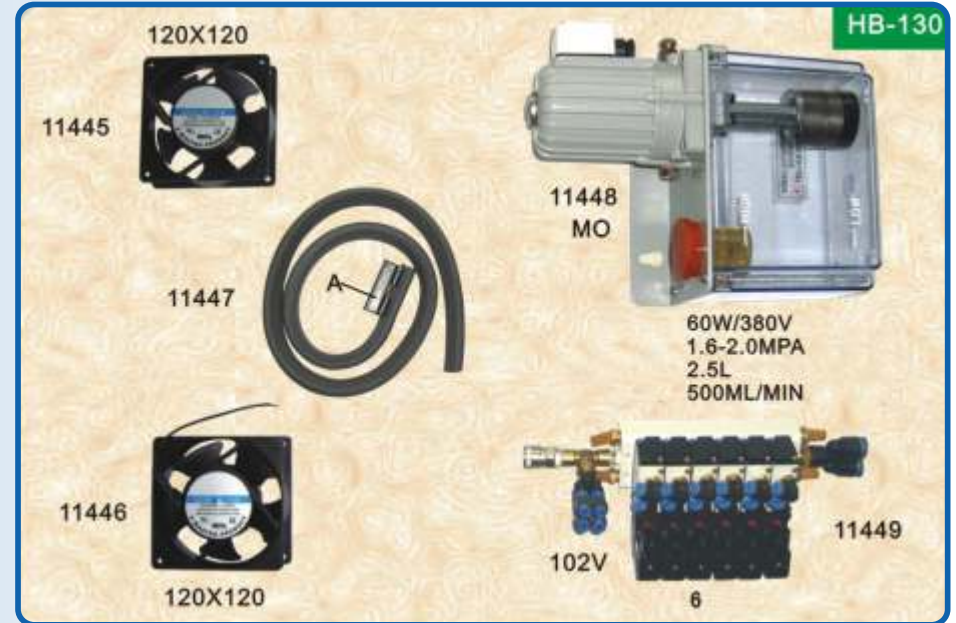

Heidelberg



Contacto: 55-5601-0265 / 55-5604-5904 / 55-5534-1708

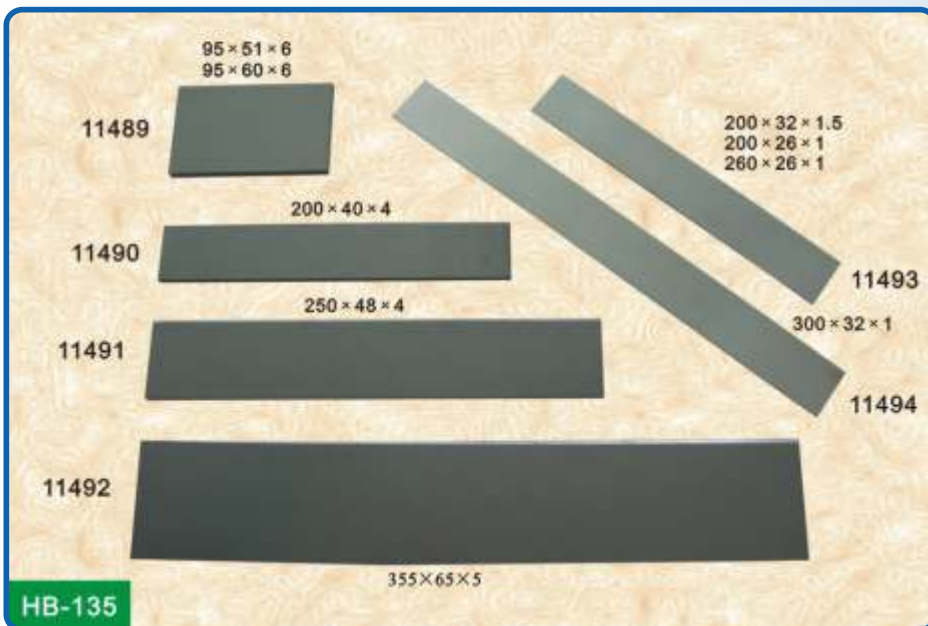
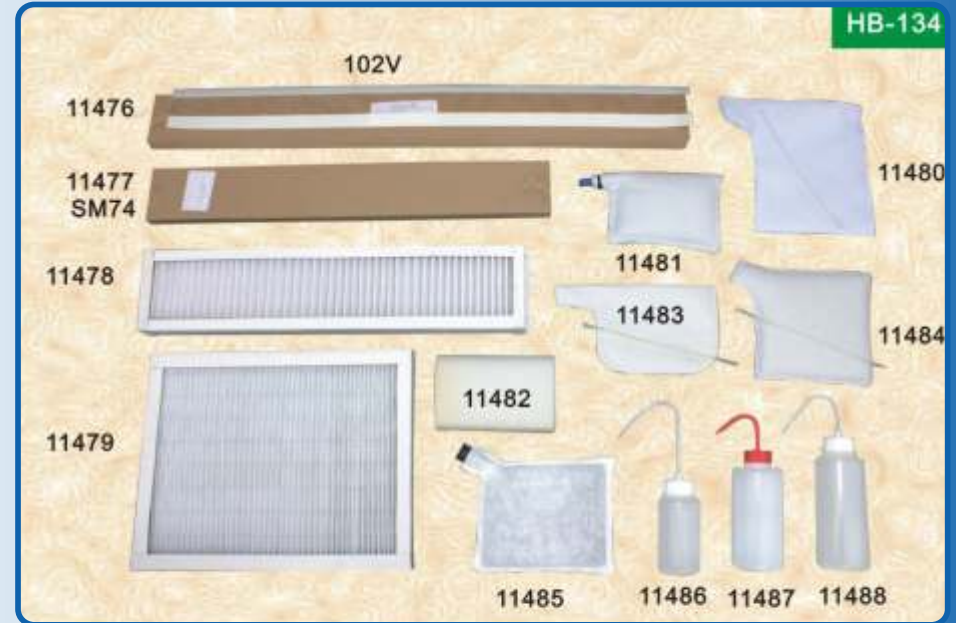
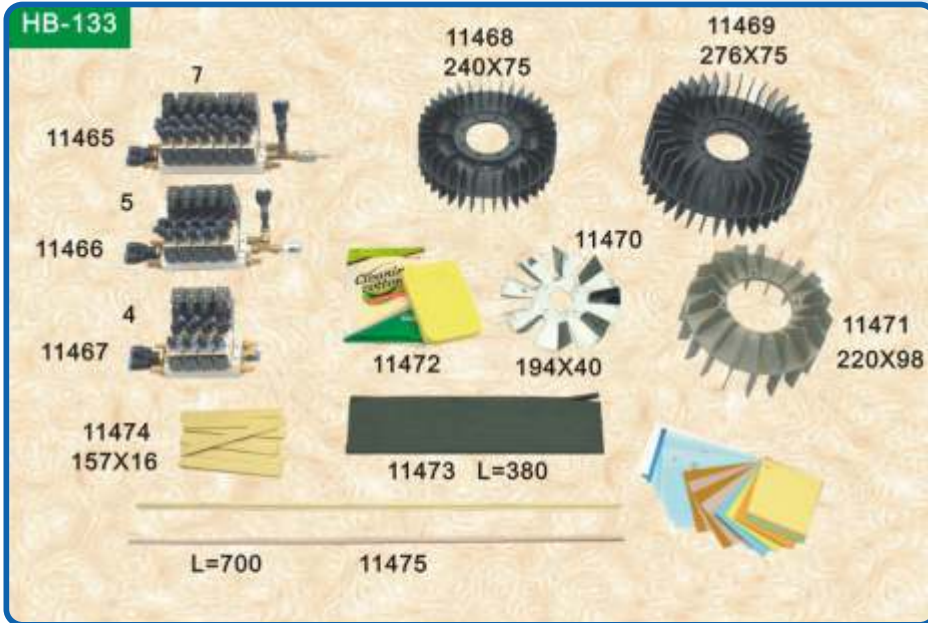

| | | |
|----------|----------|----------|
| 170X30X4 | 170X35X5 | 190X38X5 |
| 170X35X4 | 200X30X5 | 150X58X5 |
| 170X40X4 | 150X50X5 | 370X40X5 |
| 170X45X4 | 200X35X5 | 95X59X6 |
| 200X30X4 | 355X65X5 | 150X58X6 |
| 200X35X4 | 100X53X5 | 147X52X6 |
| 200X40X4 | 230X42X5 | 150X55X6 |
| 250X40X4 | 250X35X5 | 162X52X6 |
| 250X45X4 | 250X40X5 | 230X47X6 |
| 250X48X4 | 170X40X5 | 95X51X6 |
| 250X35X4 | 204X36X5 | 180X65X6 |
| 230X35X4 | 230X45X5 | 150X50X6 |
| 265X48X4 | 230X47X5 | 162X50X7 |
| 230X42X4 | 260X40X5 | 147X58X7 |
| 150X50X4 | 215X52X5 | |
| 265X40X4 | 260X52X5 | |

HB-136

1.2×25×30M
1.5×25×30M
1×28×30M
1.2×28×30M
1.5×28×30M
1×20×30M
1×25×30M

11495

11496

0.8×25×30-100M
0.8×28×30-100M
0.8×20×30-100M
1×28×30-100M
1×30×30-100M

11497

11498

11499

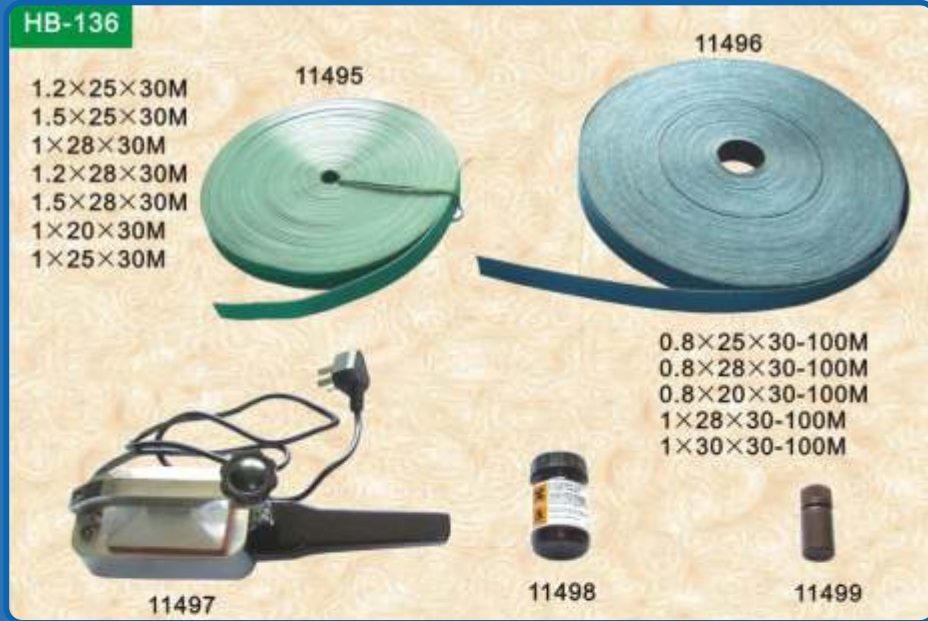

HB-137

11500

11501

6

40#
60#

11502

11503

11504



11505

11506

11507

102V

70mm×25m

H=145 d=92

H=204 d=69

11508

11509

HB-138



11510

H=128 D=50

H=248 D=68

11514

11515

H=125 D=50

H=170 D=46

11516

11517

L=1325X55

H=86 D=53

H=160 D=50

11513

11518

11519

11511

11512

11520

11521

L=960X60

L=1325X55

H=41 D=58

H=130 D=38

HB-139



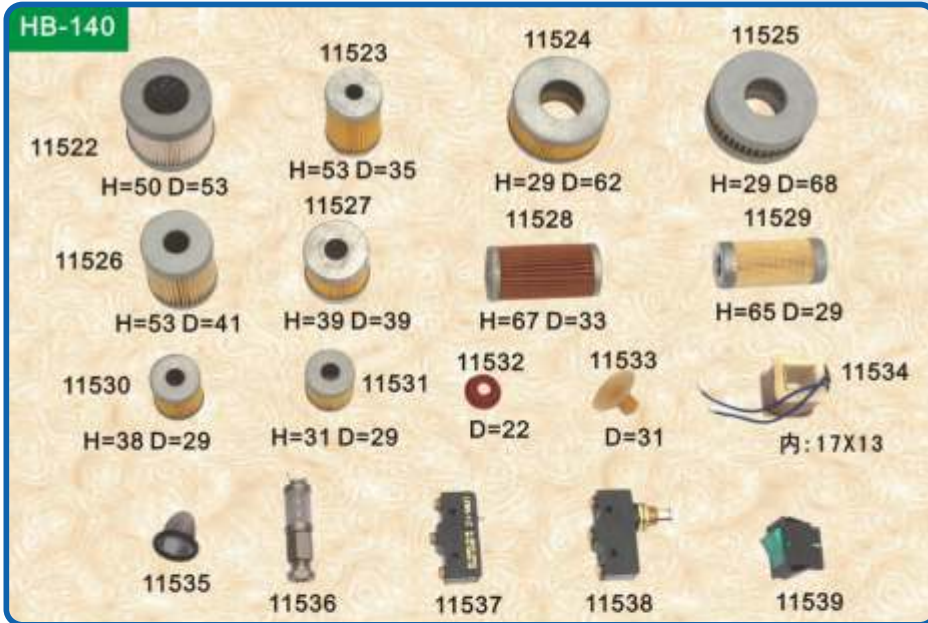

HB-144 T=0.3-3MM

11579 11580 11581 11582 11583 11584
 45X15 38X13 38X13 30X13 38X13 30X13

11585 11586 11587 11588 11589 11590
 38X13 32X13 30X13 26X6 38X13 30X13

11591 11592 11593 11594 11595 11596 11597
 38X13 32X13 30X13 24X10 22X3 22X5 22X7

HB-145

11598 11599 11600
 $\phi=14/15$
 T=0.5-2MM
 D=32, 35, 38, 45
 32X7 26X4

GTO D=19 GTO D=17
 D=27 D=27
 11601 11602 11603 11604

11605 11606 11607
 38X15X0.3-1MM 35X15X0.3-1MM 32X15X0.3-1MM

HB-146

11608
 102V L=1000 $\phi=70$

11609
 320# 180# 1150mm x 20m

HB-147

11610

| | | | | | |
|-----|----|-------|------|-----|--------|
| 44# | 44 | 25-30 | 108# | 89 | 61-63 |
| 52# | 51 | 35-40 | 116# | 95 | 68-70 |
| 64# | 70 | 40-45 | 124# | 102 | 74-77 |
| 76# | 76 | 45-50 | 132# | 108 | 85-88 |
| 84# | 82 | 50-55 | 140# | 114 | 90-93 |
| 96# | 89 | 57-60 | 148# | 120 | 96-100 |

11611



HB-152



HB-153



HB-50

HB-154



HB-155

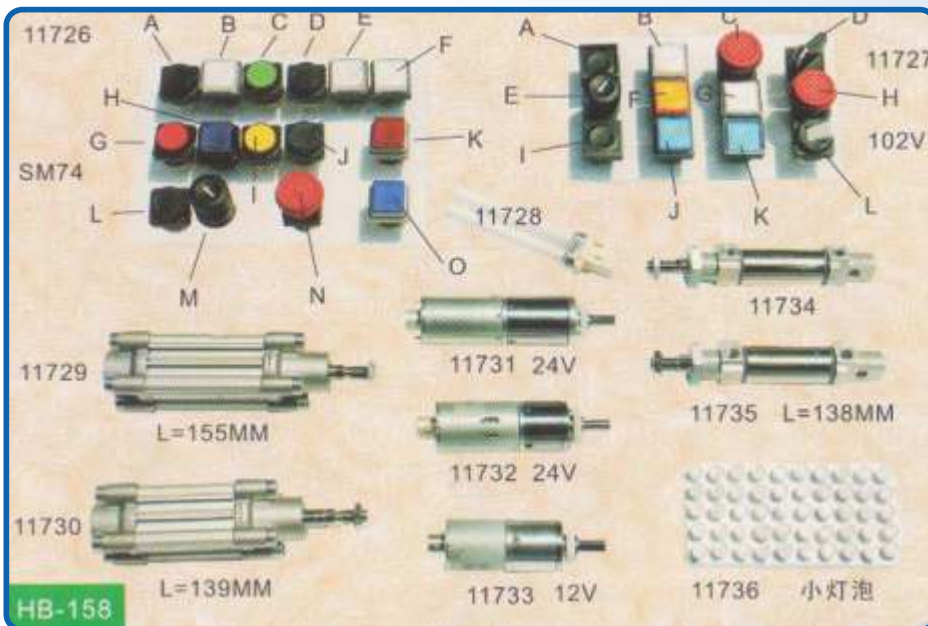

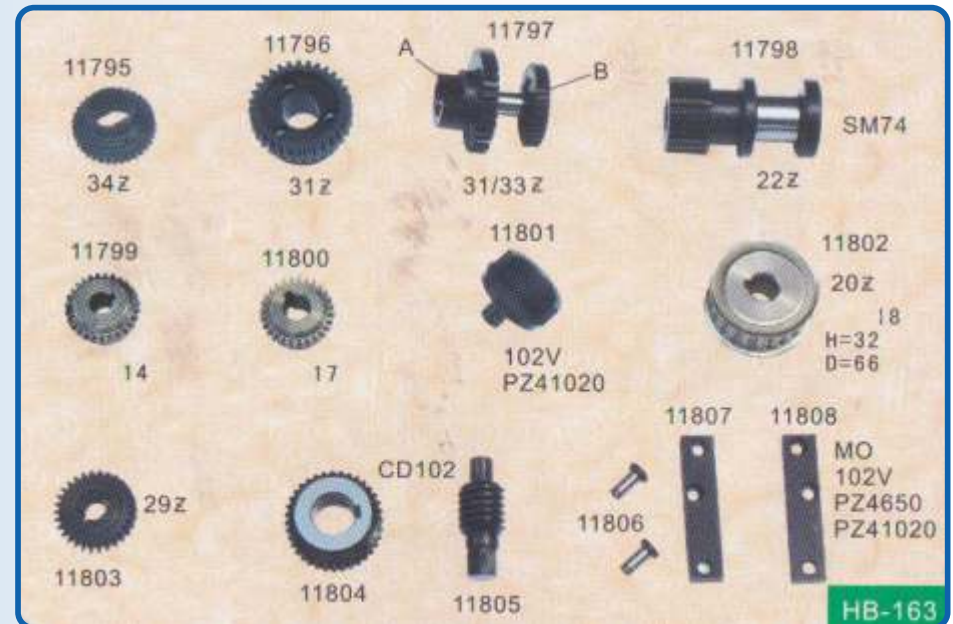
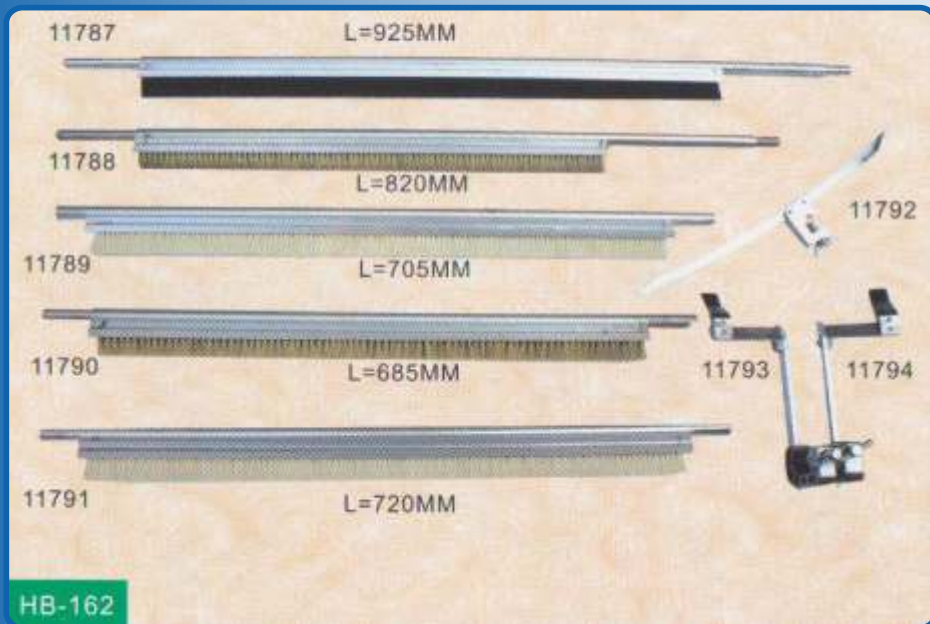

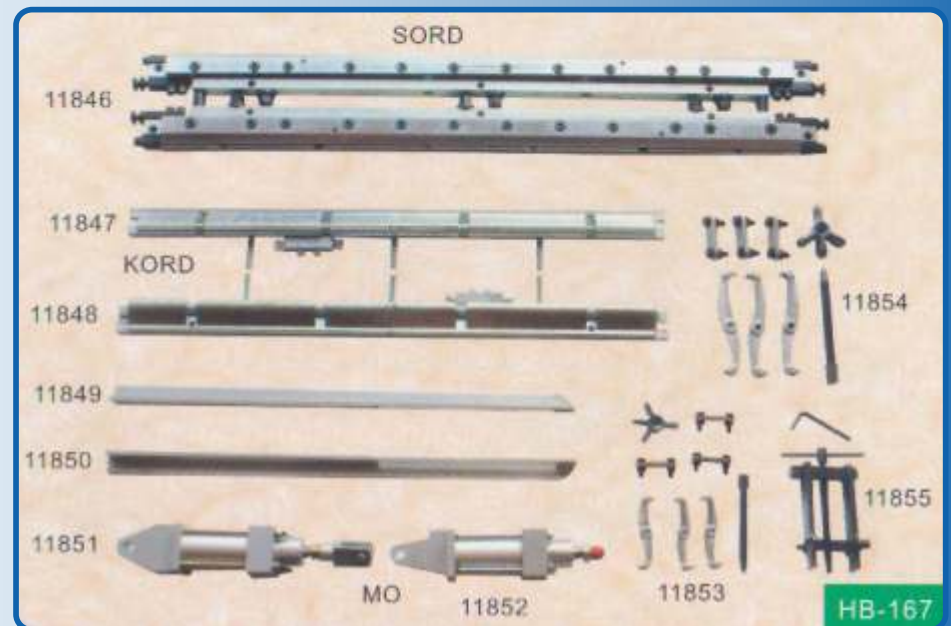
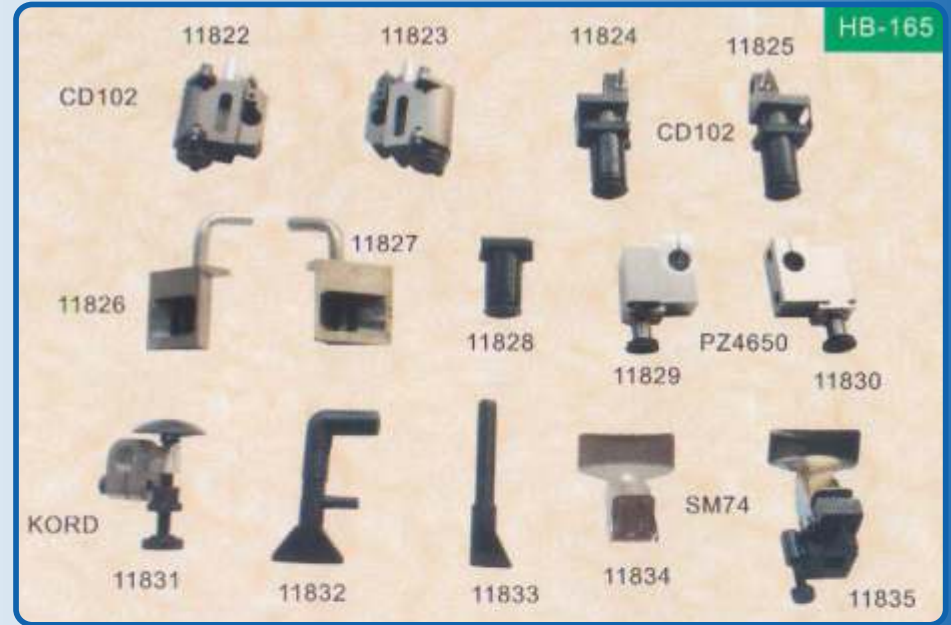
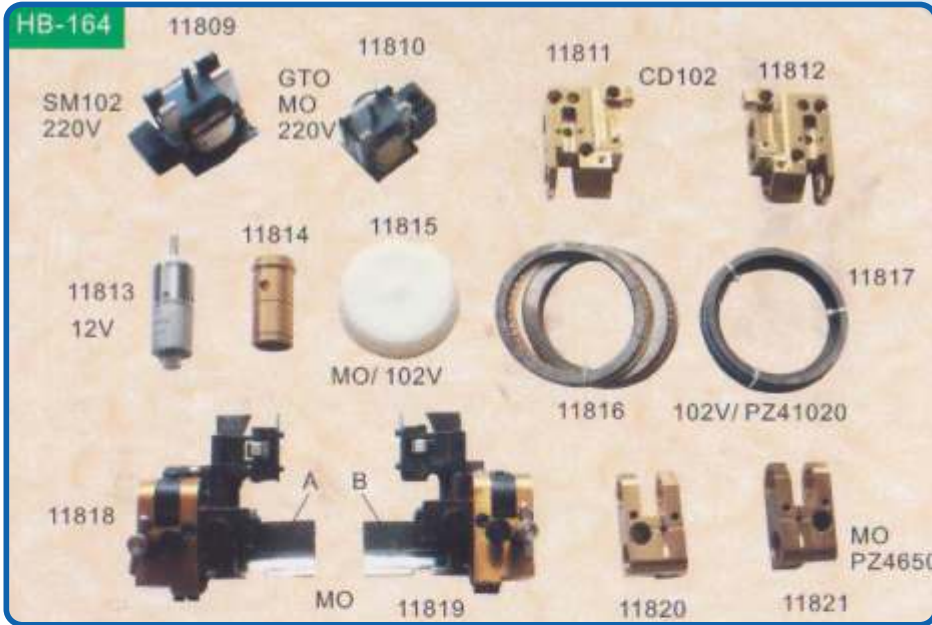

HB-168

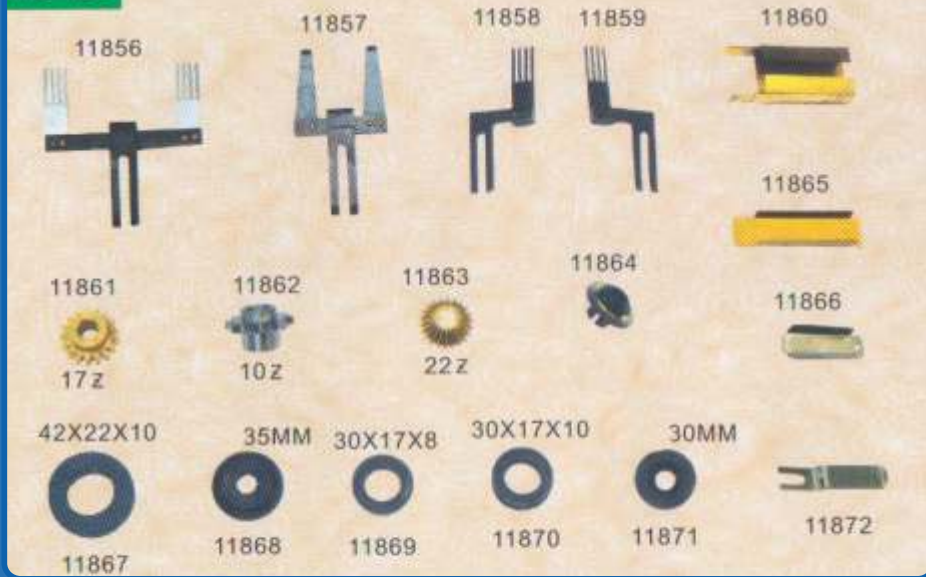

HB-169

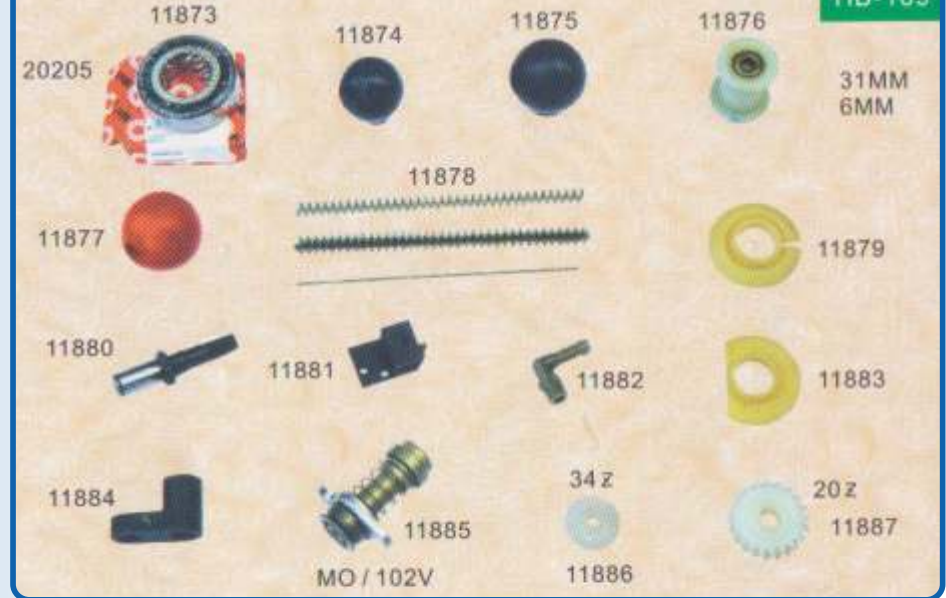

HB-170



HB-171

HB-172

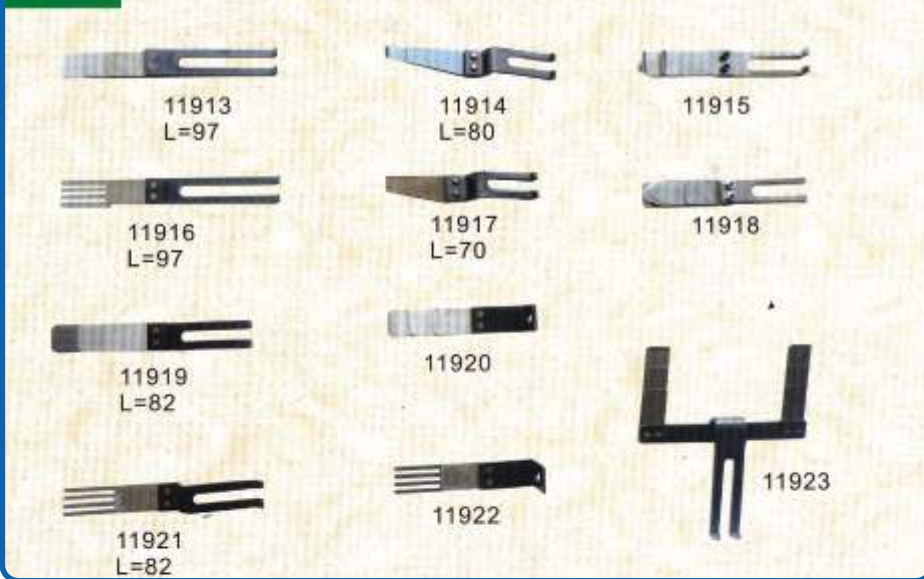

HB-173

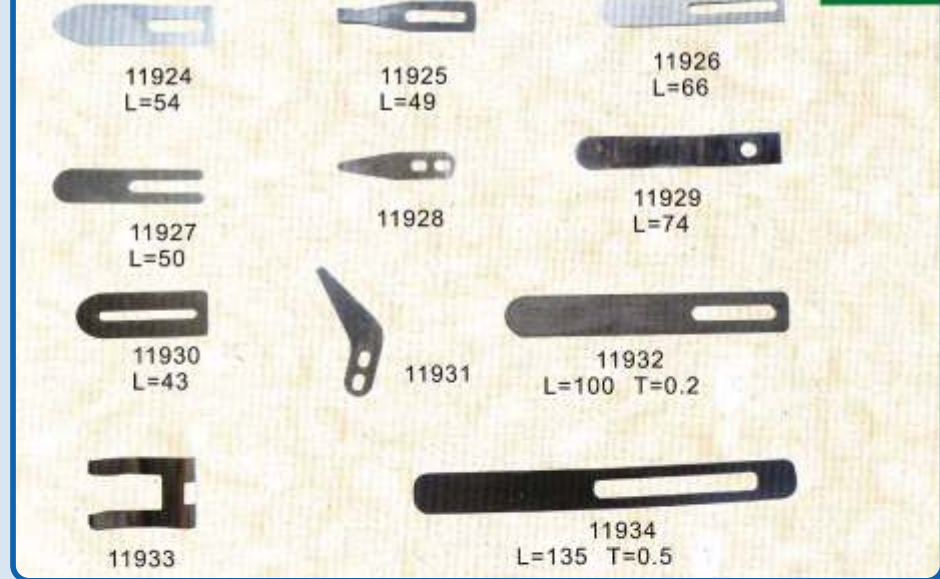

HB-174

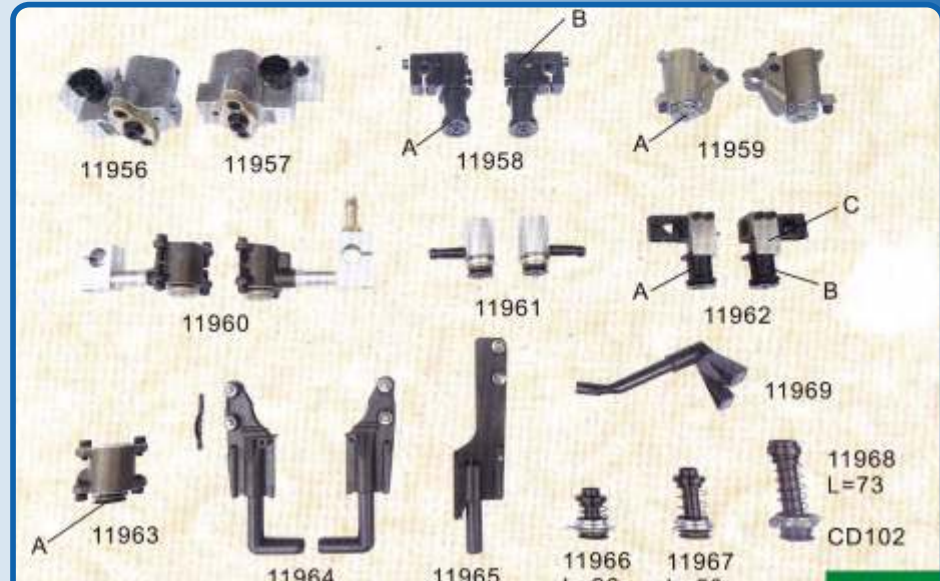

HB-175

HB-176

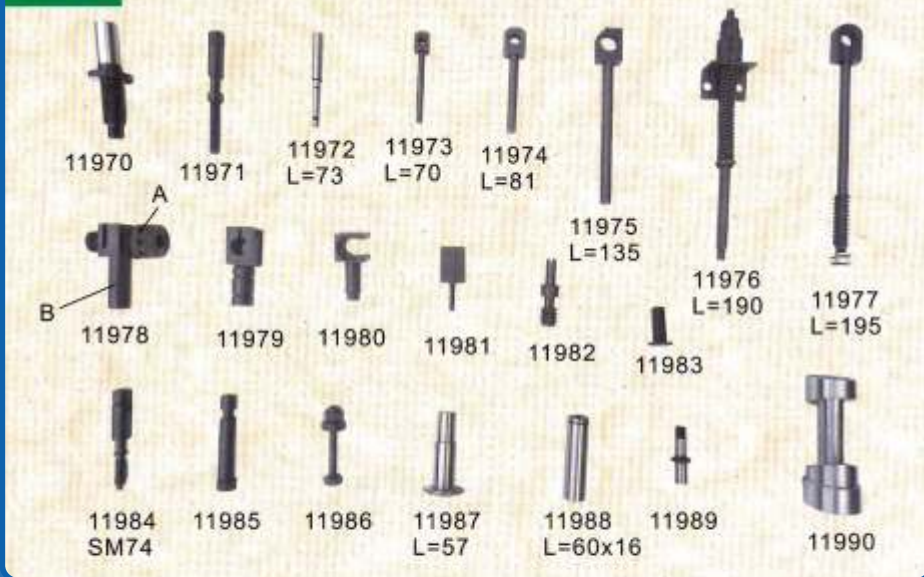

HB-177

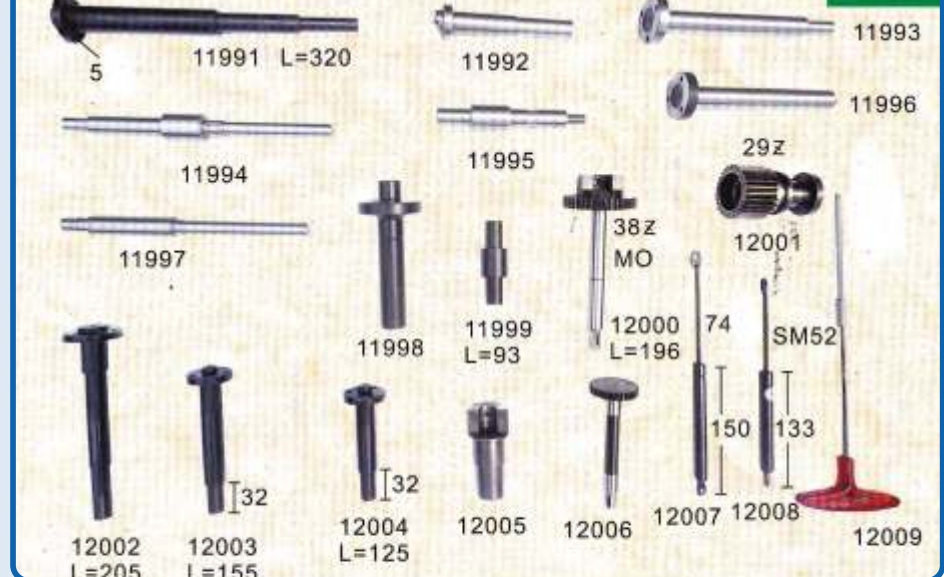

HB-178

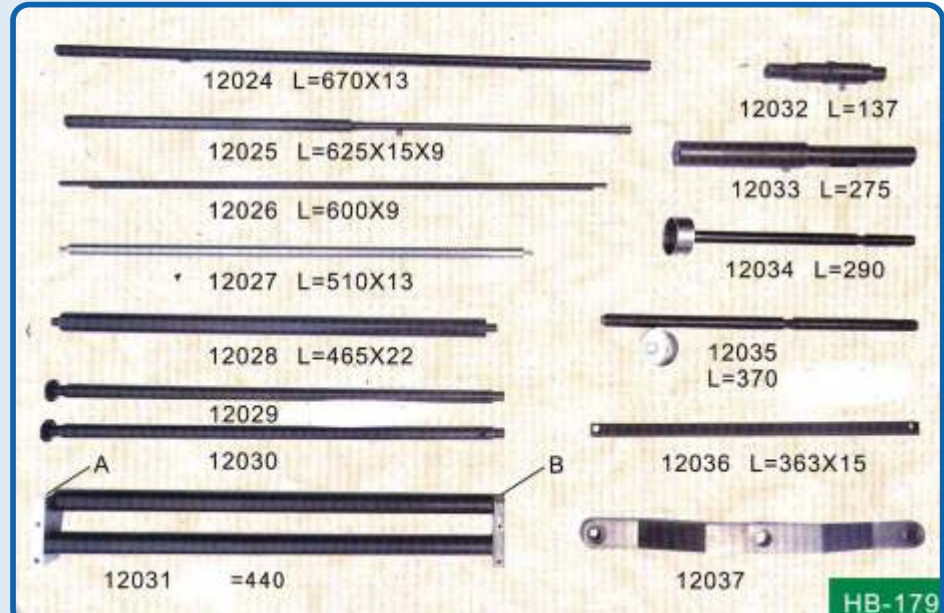

HB-179

Heidelberg



Contacto: 55-5601-0265 / 55-5604-5904 / 55-5534-1708

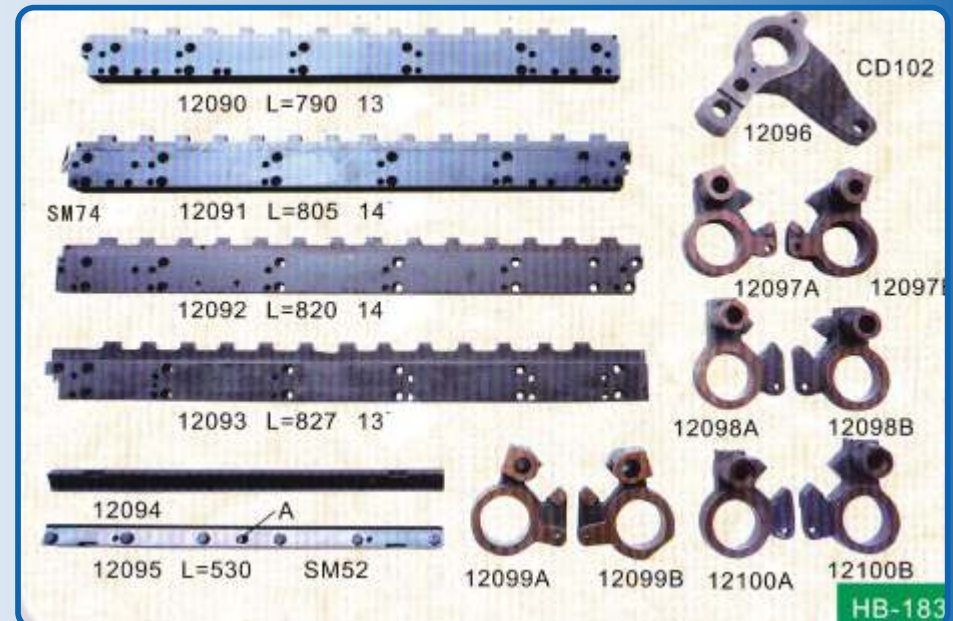
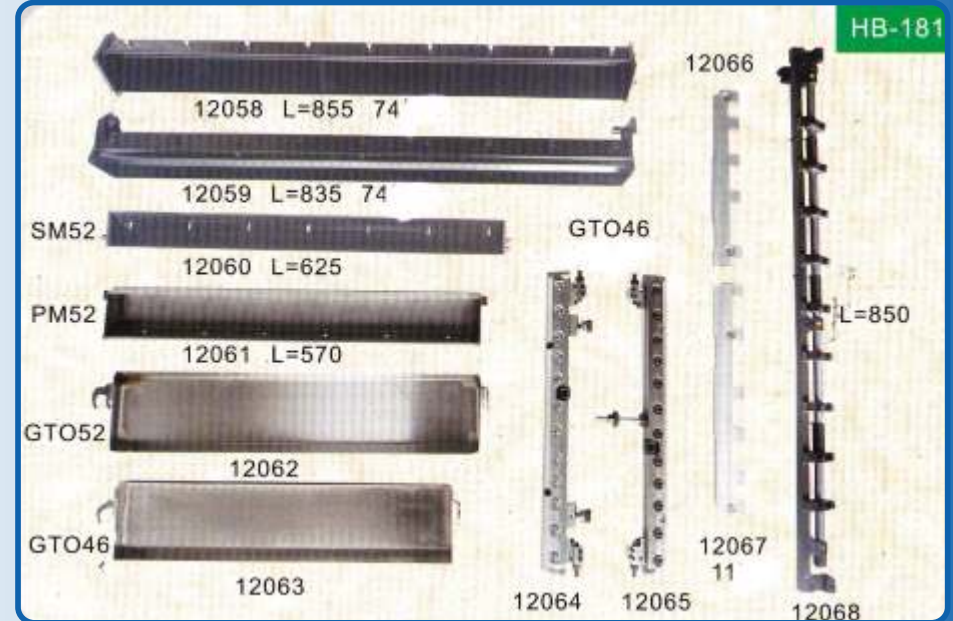

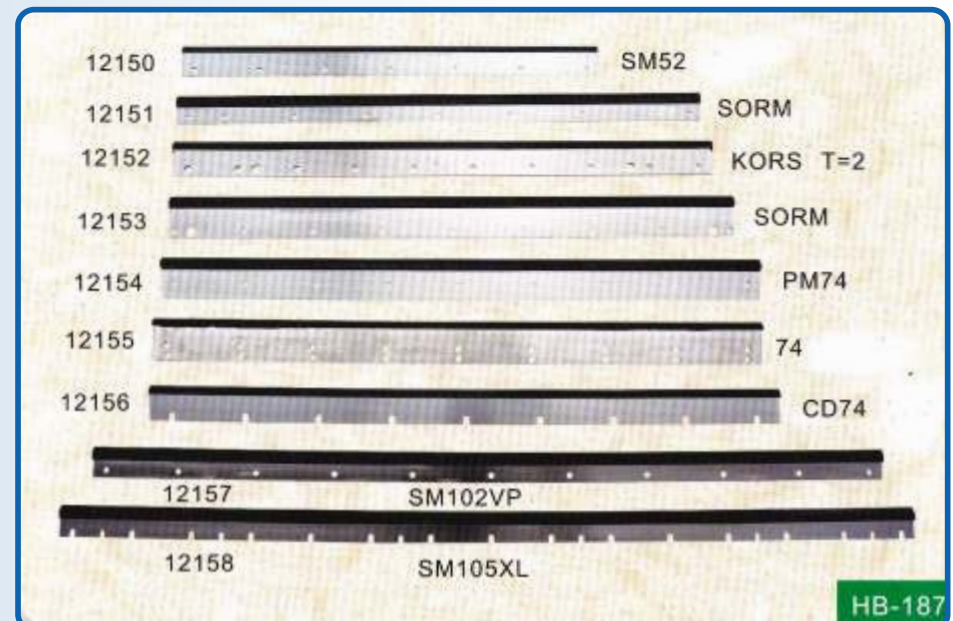
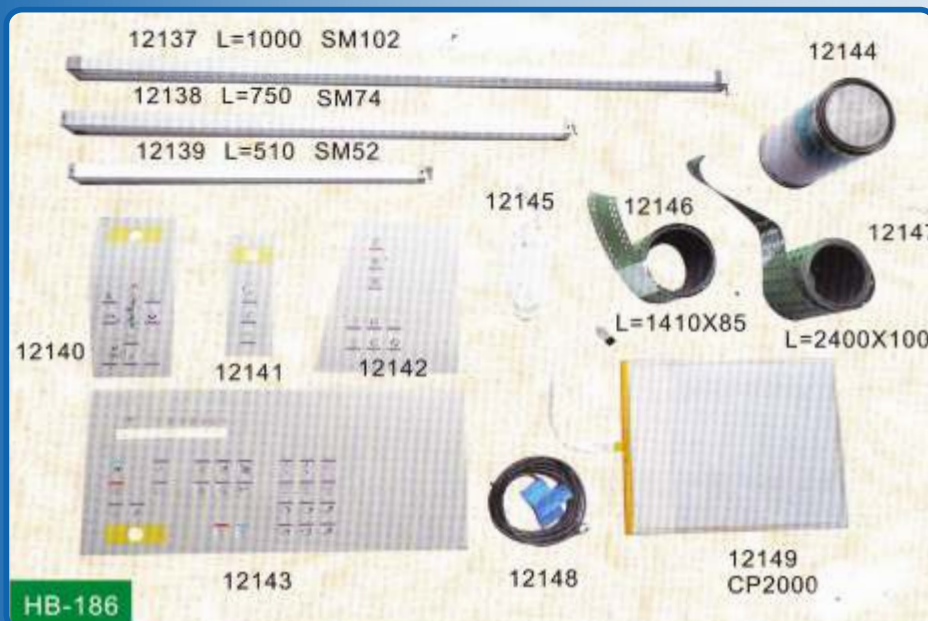

HB-188

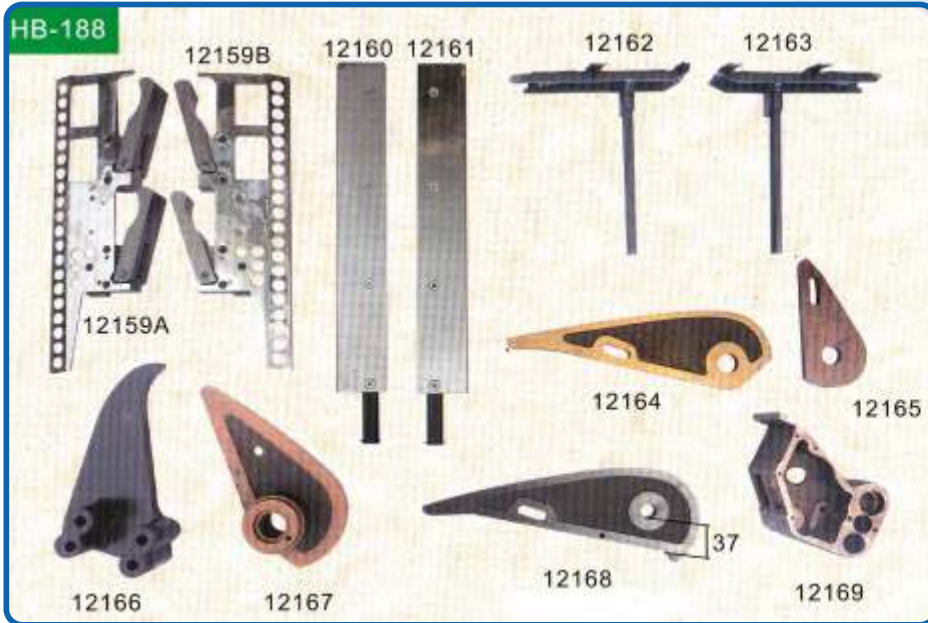

HB-189

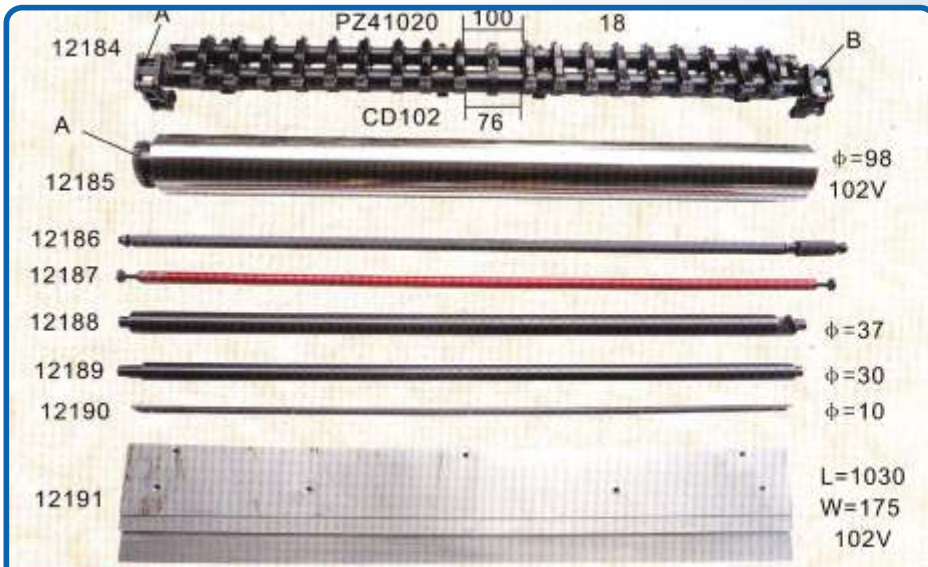
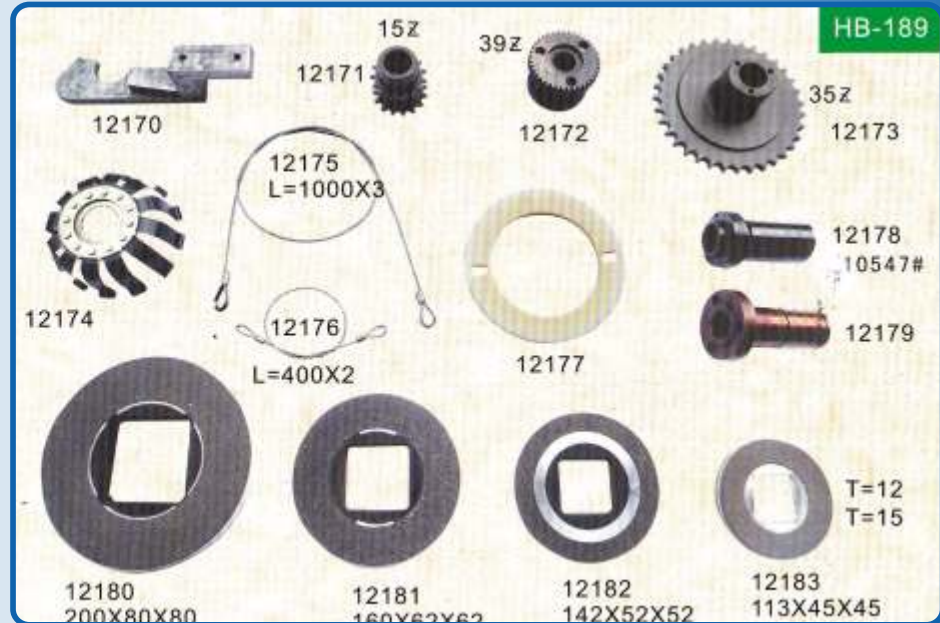

HB-190

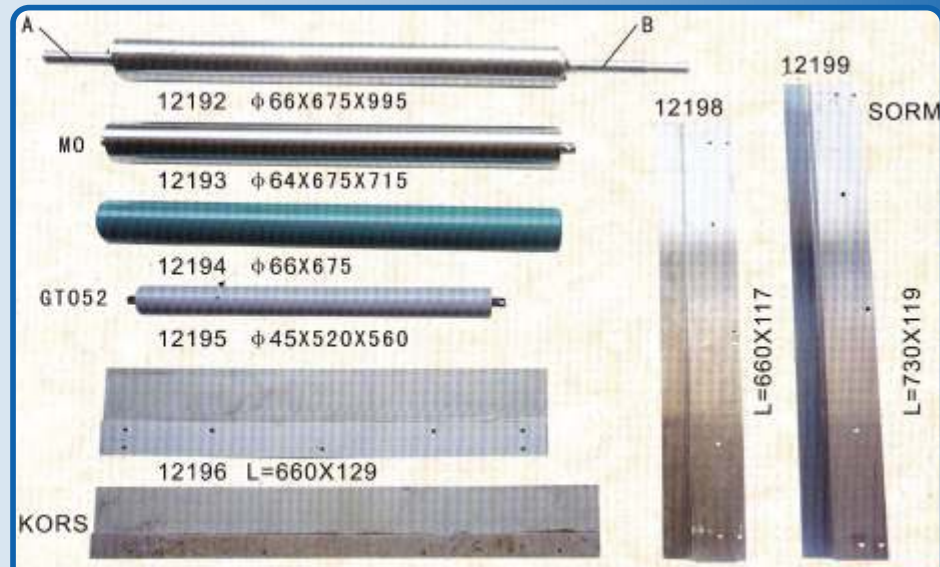

HB-191

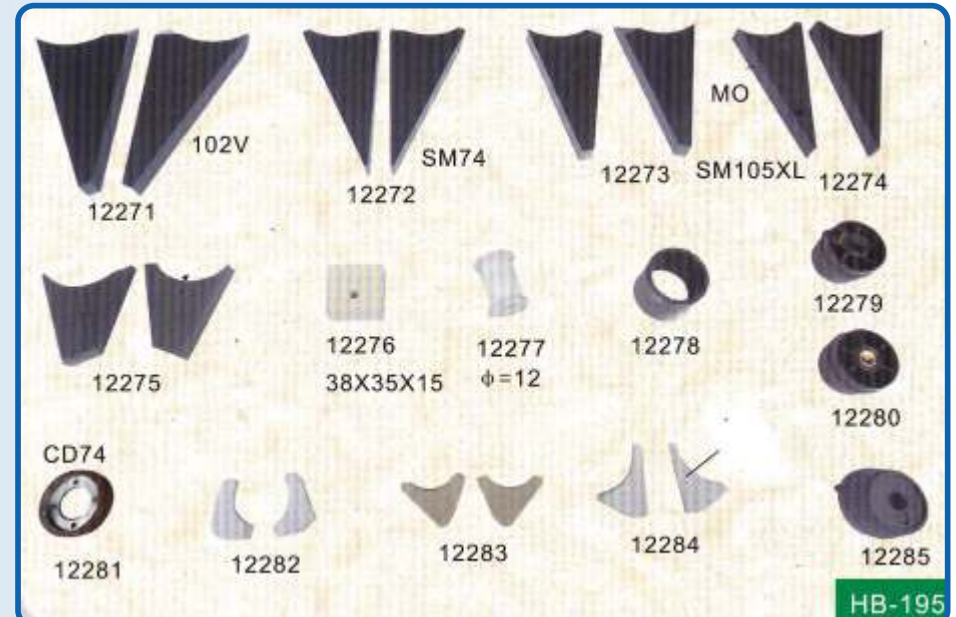

Heidelberg



Contacto: 55-5601-0265 / 55-5604-5904 / 55-5534-1708



HB-200



HB-201



HB-202

HB-203

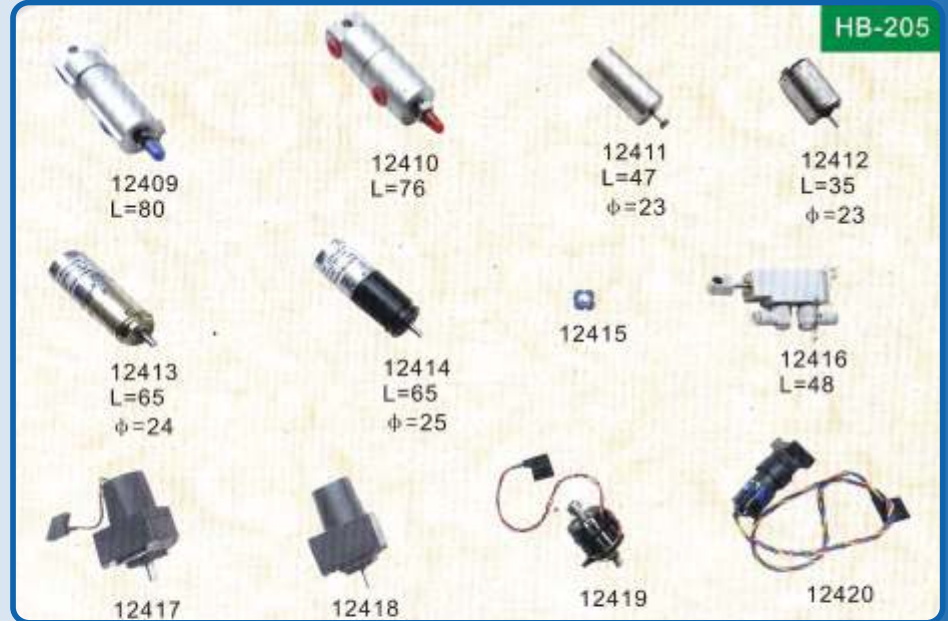

HB-208



HB-209

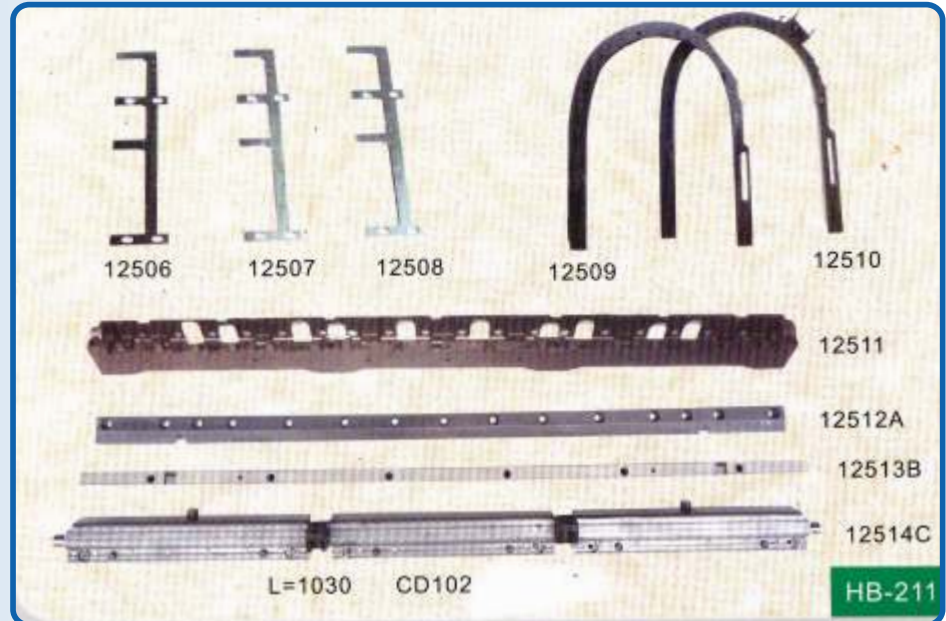
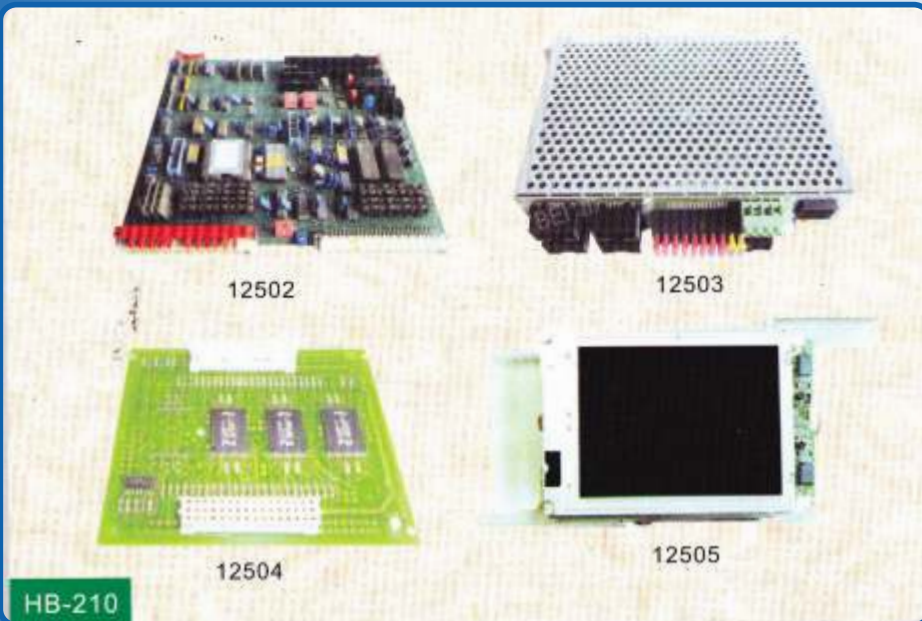

HB-210

HB-211